



## CATALOGUE

Our company is a one-stop-shop for cosmetic packaging needs, offering services from concept design to final production.



Parco-Pack GmbH, D-78467 Konstanz  
+49-7531-81'85'30 – [Office@parco-pack.de](mailto:Office@parco-pack.de)

# TABLE OF CONTENTS

JP	3A
HW	4
SANDRA	5A
SANDRA	5B
MALI	6
DP	7
DG	8
BODY	9
LILIAN	10
LUCA	11
VITAMIN E	12
MILK	13
GEVER	14
MALBEN	15
SW	16
AROMA	17
TW	18
NY	19
NY ALE	20
NYCR	21
NYB	22
NYD	23
RD	24

RD	25
RD	26
LA	27
SAPIR	28
ZOHAR	29
TALIA	30
BOSTON	31
LIFE	32
YAFIT	33
CLAUDIA	34
BISS	35
AGAS	36
DIANA	37
PRO V	38
OV	39
SQM	40
SMADAR	41
PAAMON	42
IND	43
SPECIAL 1-200	44
SPECIAL 201-500	45
SPECIAL 501-1000	46
ONE LITER	47

MG	48
SASA	49
WS	50
LYN	51
NL	52
BALLS	53
KOPA	54
INBAR	55
GEL	56
NF	57
RCO	58
YAEL	59
YG	60
CARMIT	61
BOTANIC	62
AMIGOS	63
ROLL ON	64
CANDELA	65
GALI	66
FOAM	67
MED	68
TALC	69
CLOSURES	70



# TABLE OF CONTENTS

AGAS	36
AMIGOS	4
AROMA	17
BALLS	53
BISS	35
BODY	9
BOTANIC	63
BOSTON	31
CANDELA	65
CARMIT	61
CLAUDIA	34
DG	8B
DG PET	8A
DIANA	37
DP	7
GALI	66
GEL	56
GEVER	14
HW	4
INBAR	55
IND	43
JP	3
KOPA	54

LA	27
LIFE	32
LILIAN	10
LUCA	11
LYN	51
MALBEN	15
MALI	6
MG	48
MILK	13
NY	19
NY ALE	20
NYB	22
NYCR	21
NYD	23
NF	57
NL	52
ONE LITRE	47
OV	39
PAAMON	42
PRO V	38
RD	25
RD PET	24
RD	26

RCO	58
ROLL ON	64
SASA	49
SANDRA	5A
SANDRA PET	5B
SAPIR	28
SMADAR	41
SPECIAL 1-200	44
SPECIAL 201-500	45
SPECIAL 501-1000	46
SQM	40
SW	16
TALIA	30
TW	18
VITAMIN E	12
WS	50
Yael	59
YAFIT	33
YG	60
ZOHAR	29
CLOSURES	70



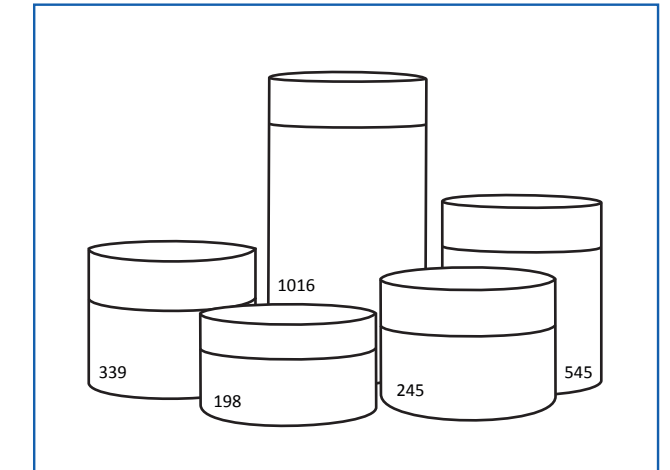

REF	VOL	H mm	D mm	CAP	NECK FINISH	MATERIAL
92	100	40	94	ST16/ST25/AL/R3/ALU 16/ALU25/NYJ/D/GAL	89 / 400	PET
7125	125	45	73	ST12 /ST20 / D	70 / 400	PET
7150	150	51	73	ST12 /ST20 / D	70 / 400	PET
198	180	49	94	ST16/ST25/AL/R3/ALU 16/ALU25/NYJ/D/GAL	89 / 400	PET
7200	200	63	73	ST12 /ST20 / D	70 / 400	PET
7250	250	77	73	ST12 /ST20 / D	70 / 400	PET
245	250	61	94	ST16/ST25/AL/R3/ALU 16/ALU25/NYJ/D/GAL	89 / 400	PET
399	350	68	94	ST16/ST25/AL/R3/ALU 16/ALU25/NYJ/D/GAL	89 / 400	PET
545	500	95	94	ST16/ST25/AL/R3/ALU 16/ALU25/NYJ/D/GAL	89 / 400	PET
1016	1000	172	93	ST16/ST25/AL/R3/ALU 16/ALU25/NYJ/D/GAL	89 / 400	PET



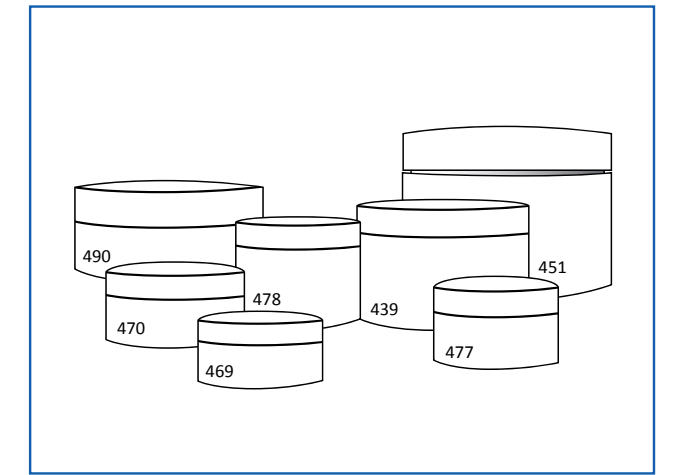

REF	VOL	H mm	D mm	CAP	NECK FINISH	MATERIAL
382	10	26	33	A	Special	PS
469	15	28	60	ST13/ST21/D/AL /ALU18/R3	58 / 400	PP
477	30	33	60	ST13/ST21/D/AL /ALU18/R3	58 / 400	PP
478	50	46	60	ST13/ST21/D/AL /ALU18/R3	58 / 400	PP
143	50	45	70	ST 15 ref 234 / ST 18 ref 182	Special	Acrylic
173	50	47	60	ST13/ST21/D/AL/ALU 18/R3 /ST22 ABS	58 / 400	PETG
247	50	45	56	ST13 Special 249	53 / 400	PP
137	50	25	73	ST12/ST20/D	70 / 400	PP
470	60	32	71	ST12/ST20/D	70 / 400	PP
490	150	38	91	ST16/ST25/AL/R3/ALU 16/ALU25/D/GAL	89 / 400	PP
439	250	56	91	ST16/ST25/AL/R3/ALU 16/ALU25/D/GAL	89 / 400	PP
252 S	250	56	91	ST16/ST25/AL/R3/ALU 16/ALU25/D/GAL	89 / 400	PP
451	400	71	103	ST18	100 / 400	PP
261	250	69	88	Cap85mm ref260	85/400	PP
550 PE	250	69	88	Cap85mm ref260	85/400	PET



# SANDRA



REF	VOL	H mm	D mm	CAP	NECK FINISH	MATERIAL
<b>BOTTLES</b>						
72	75	84	43	LP/FT/DT	24/410	PE/PP
131	100	120	39	LP/FT/DT	24/410	PE/PP
132	120	126	41	LP/FT/DT	24/410	PE/PP
134	150	134	45	LP/FT/DT	24/410	PE/PP
150 A	150	118	47	LP/FT/DT	24/410	PE/PP
150 B	150	114	47	FT 410	Snap	PE/PP
215	220	120	56	LP/FT/DT	24/410	PE
224	240	146	54	LP/FT/DT	28/410	PE/PP
225 A	240	146	54	LP/FT/DT	24/410	PE/PP
225 B	240	142	54	FT 410	Snap	PE/PP
246 A	230	173	46	LP/FT/DT	24/410	PE/PP
246 B	230	168	46	FT 410	Snap	PE/PP
279 A	250	174	49	LP/FT/DT	24/410	PE/PP
279 B	250	169	49	FT 410	Snap	PE/PP
299	300	190	52	LP/FT/DT	24/410	PE/PP
323	300	151	59	LP/FT/DT	28/410	PE/PP
359 A	350	187	57	LP/FT/DT	24/410	PE/PP
359 B	350	183	57	FT 410	Snap	PE/PP
547 A	500	134	64	LP/FT/DT	24/410	PE/PP
547 B	500	195	64	FT 410	Snap	PE/PP
1014	1000	197	91	LP/FT/DT	28/410	PE/PP
1018	1000	263	77	LP/FT/DT	28/410	PE/PP
1021	1160	286	77	LP/FT/DT	28/411	PE/PP



FOR CAPS AND CLOSURES PLEASE TURN TO PAGE 70



Parco-Pack GmbH, D-78467 Konstanz  
+49-7531-81'85'30 – Office@parco-pack.de

# SANDRA



REF	VOL	H mm	D mm	CAP	NECK FINISH	MATERIAL
-----	-----	------	------	-----	-------------	----------

## BOTTLES PET

1103	100	125	39	LP/SP/DT /FT	24/410	PET
1155	150	150	42	LP/DT	24/410	PET
1262	250	173	49	LP/FT/DT	24/410	PET
1264	250	120	64	LP/FT/DT	24/410	PET
1319	300	145	62	LP/SP/DT /FT	28/410	PET
1506	500	235	59	LP/SP/DT /FT	28/410	PET



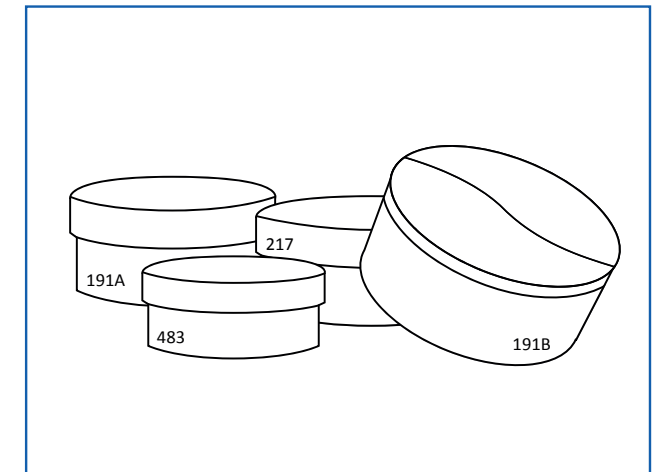

REF	VOL	H mm	D mm	CAP	NECK FINISH	MATERIAL
136	200	33	116	ST19 /SW 539	118/400	PP
191AM&S	200	41	99	SW 459	Special	PP
191 BS	2x100	41	99	SW 459	Special	PP
190	350	51	116	ST19 /SW 539	118/400	PET
540	350	51	116	ST19 /SW 539	118/400	PP
483	50	28	68	SW 484	Special	PP



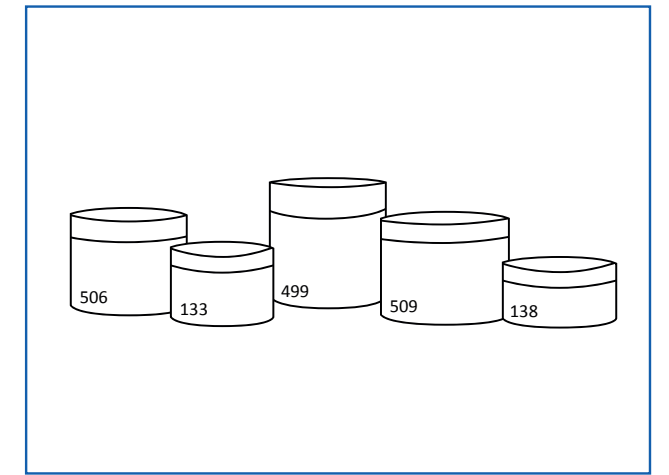

REF	VOL	H mm	D mm	CAP	NECK FINISH	MATERIAL
138 S	50	38	72	ST12/ST20/D/GAL	70/400	PP
163 M	50	38	72	ST12/ST20/D/GAL	70/400	PP
133 S	100	49	72	ST12/ST20/D/GAL	70/400	PP
546 M	100	49	72	ST13/ST21/D/AL/ALU 18/R3	70/400	PP
170/507 DPH S	200	67	92	ST16/ST25/AL/R3/ALU 16/ALU25/D/GAL	89/400	PP
170/508 DPH S	250	67	92	ST16/ST25/AL/R3/ALU 16/ALU25/D/GAL	89/400	PP
506/ 507M	200-54	67	92	ST16/ST25/AL/R3/ALU 16/ALU25/D/GAL	89/400	PP
506/ 508M	250-54	67	92	ST16/ST25/AL/R3/ALU 16/ALU25/D/GAL	89/400	PP
509/ 507M	200-54	67	92	ST16/ST25/AL/R3/ALU 16/ALU25/D/GAL	89/400	PP
509/ 508M	250-54	67	92	ST16/ST25/AL/R3/ALU 16/ALU25/D/GAL	89/400	PP
499/ 500M	250-54	80	92	ST16/ST25/AL/R3/ALU 16/ALU25/D/GAL	89/400	PP
169 S	250	100	70	ST12/ST20/D/GAL	70/400	PP



# DG PET

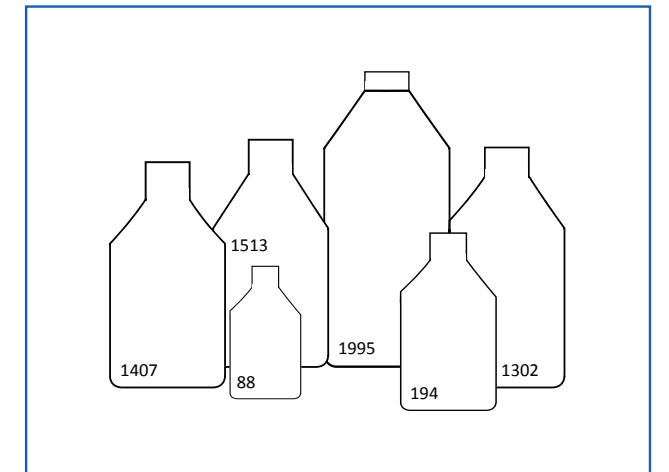

REF	VOL	H mm	D mm	CAP	NECK FINISH	MATERIAL
-----	-----	------	------	-----	-------------	----------

## BOTTLES

88	100	105	41	SP / DT / LP	24/410	PE
194	250	105	67	SP / DT / LP	28/400	PE
320	300	143	61	SP / DT / LP	24/410	PE
373	350	124	72	SP / DT / LP	28/400	PE
507	500	125	86	SP / DT / LP	28/400	PE
1061	60	75	41	ST/LP/DT/FT	20/410	PET
1212	200	105	60	DT/SP	24/410	PET
1302	300	143	61	SP / DT / LP	24/410	PET
1320	320	182	53	SP / DT / LP	28/410	PET
1407	400	139	72	SP / DT / LP	28/410	PET
1509	500	160	72	SP / DT / LP	28/410	PET
1513	500	157	73	SP / DT / LP	24/410	PET
1995	1000	225	81	LP	33/400	PET



FOR CAPS AND CLOSURES PLEASE TURN TO PAGE 70



Parco-Pack GmbH, D-78467 Konstanz  
+49-7531-81'85'30 – Office@parco-pack.de

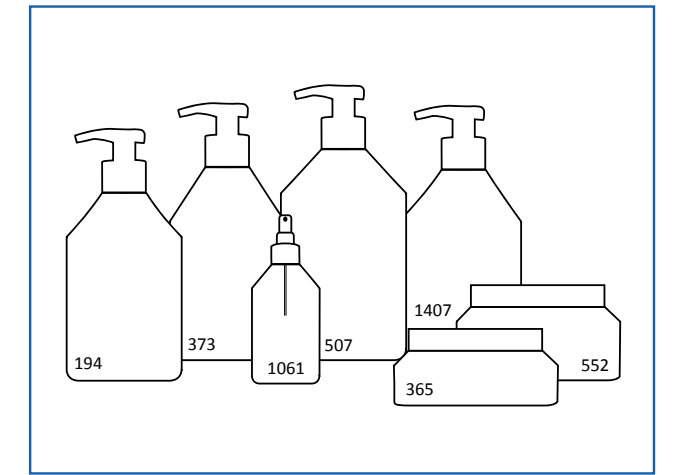

REF	VOL	H mm	D mm	CAP	NECK FINISH	MATERIAL
-----	-----	------	------	-----	-------------	----------

**BOTTLES**

88	100	105	41	SP / DT / LP	24/410	PE
194	250	105	67	SP / DT / LP	28/400	PE
320	300	143	61	SP / DT / LP	24/410	PE
373	350	124	72	SP / DT / LP	28/400	PE
507	500	125	86	SP / DT / LP	28/400	PE
1061	60	75	41	ST/LP/DT/FT	20/410	PET
1212	200	105	60	DT/SP	24/410	PET
1302	300	143	61	SP / DT / LP	24/410	PET
1320	320	182	53	SP / DT / LP	28/410	PET
1407	400	139	72	SP / DT / LP	28/410	PET
1509	500	160	72	SP / DT / LP	28/410	PET
1513	500	157	73	SP / DT / LP	24/410	PET
1995	1000	225	81	LP	33/400	PET

**JARS**

365	350	58	110	ST16/ST25/AL/R3 /ALU16/ALU25	89/400	PET
552	500	75	110	ST16/ST25/AL/R3 /ALU16/ALU25	89/400	PET
2503	500	82	104	ST16/ST25/AL/R3 /ALU16/ALU25	89/400	PET



# BODY

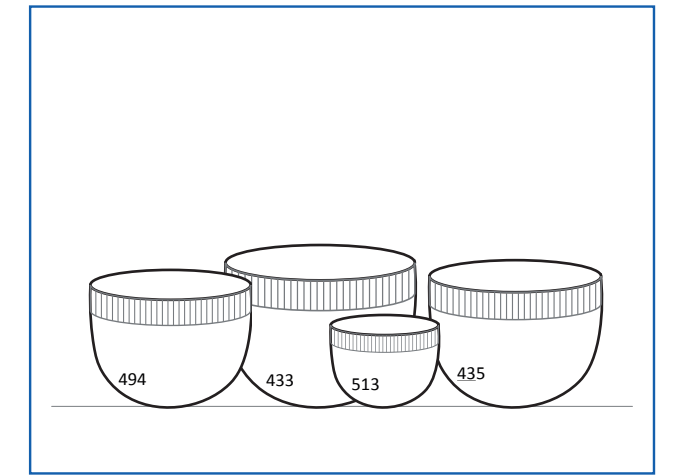

REF	VOL	H mm	D mm	CAP	NECK FINISH	MATERIAL
-----	-----	------	------	-----	-------------	----------

## BOTTLES

513	50	37	55	SW 522 / SW536	Special	PP
494	200	63	86	AL / ST15	83 / 400	PP
435	300	68	92	GAL / AL / ST16 / ST25	89 / 400	PP
2301	300	69	92	GAL / AL / ST16 / ST25	89 / 400	PET
433	500	86	102	ST 18	100 / 400	PP



# LILIAN

REF	VOL	H mm	D mm	CAP	NECK FINISH	MATERIAL
-----	-----	------	------	-----	-------------	----------

## BOTTLES

1152	150	123	46	LP / FT	24/410	PET
177	250	177	57	LP / FT	28/410	PP
1330	330	145	62	LP / FT	28/410	PET
314	330	145	64	LP / FT	28/410	PP
1403	400	154	68	LP / FT	28/410	PET
430	400	154	68	LP / FT	28/410	PP
556	500	180	68	LP / FT	28/410	PP
1505	500	180	67	LP / FT	28/410	PET
1017	1000	222	86	LP / FT	28/410	PP
1997	1000	222	85	LP / FT	28/410	PET

## JARS

511	500	80	108	ST16/ST25/AL/R3 /ALU16/ALU25	89/400	PE
2501	500	72	118	ST16/ST25/AL/R3 /ALU16/ALU25	89/400	PET
596	500	82	109	ST16/ST25/AL/R3 /ALU16/ALU25	89/400	PE?/IBM

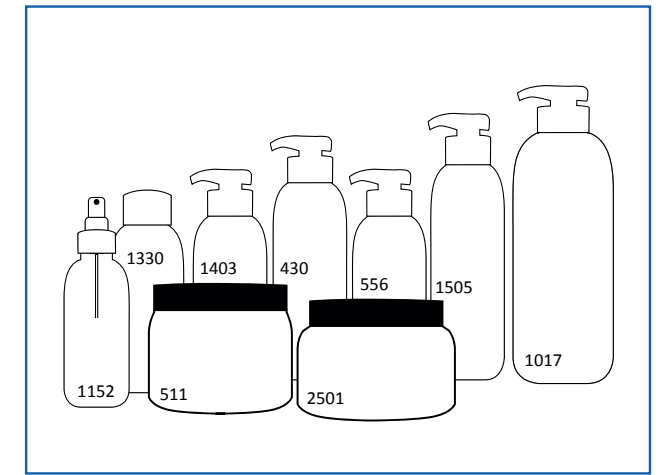

# LUCA

REF	VOL	H mm	D mm	CAP	NECK FINISH	MATERIAL
238	280	158	75	CB	Pco 28	PE
427	400	211	82	CB	Pco 28	PE
762	750	242	92	CB	Pco 28	PE

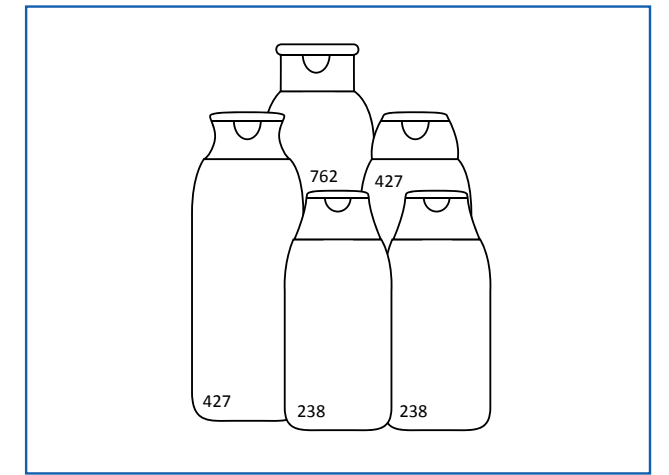

# VITAMIN E

REF	VOL	H mm	D mm	CAP	NECK FINISH	MATERIAL
411	400	163	80	LP/SP/DT/FT	28/410	PP
539	500	245	87	WP1001	Special	PP
543	500	175	80	LP/SP/DT/FT	28/410	PP

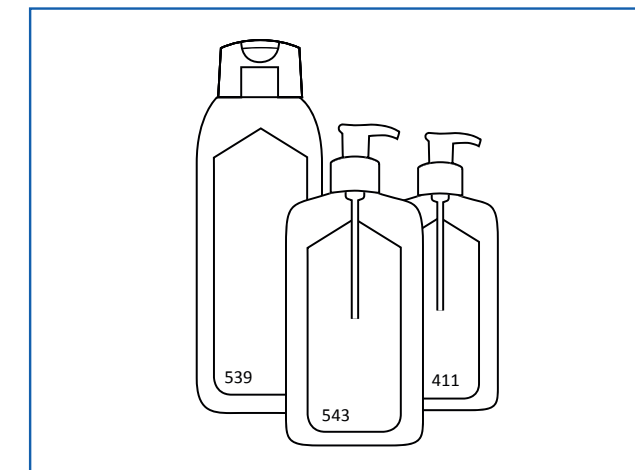

# MILK

REF	VOL	H mm	D mm	CAP	NECK FINISH	MATERIAL
-----	-----	------	------	-----	-------------	----------

## BOTTLES

146	150	134	49	LP / FT	24 / 410	PE
232	250	165	55	LP / FT	28 / 410	PE
551	500	190	70	LP / FT	28 / 410	PE
1508	500	192	68	LP/SP/DT/FT	28 / 410	PET
1015	1000	230	88	LP / FT	38 / 410	PE

## JARS

474	500	82	108	ST16/ST25/AL/R3/ ALU16/ALU25/GAL	89 / 400	PE
595	550	83	108	ST16/ST25/AL/R3/ ALU16/ALU25/GAL	89 / 400	PE
2502	500	82	104	ST16/ST25/AL/R3/ ALU16/ALU25/GAL	89 / 400	PET

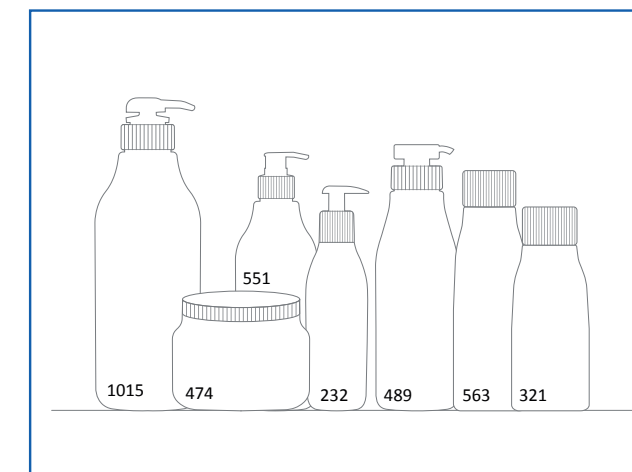

# GEVER

REF	VOL	H mm	D mm	CAP	NECK FINISH	MATERIAL
-----	-----	------	------	-----	-------------	----------

## BOTTLES

240	250	135	55	743	Special	PE
426	400	170	86	743	Special	PE
701	700	222	92	743	Special	PE

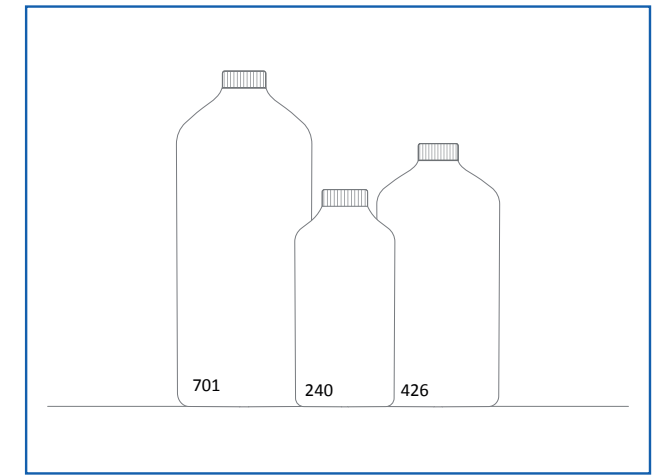

# MALBEN

REF	VOL	H mm	D mm	CAP	NECK FINISH	MATERIAL
<b>BOTTLES</b>						
94	100	115	45	SP/DT/LP/FT	20/415	PET
96	100	108	49	SP/DT/LP/FT	20/415	PE/PP
1156	150	107	40x59	SP/DT/LP/FT	24/410	PET
184	200	160	37x64	SP/DT/LP/FT	24/410	PE
1214	220	158	37x63	SP/DT/LP/FT	24/410	PET
1252	250	131	46x67	SP/DT/LP/FT	28/410	PET
217	250	118	90	ST/LP/DT/FT	28/410	PE
1301	300	170	75	SP/DT/LP/FT	28/410	PET
387	400	177	45x83	SP/DT/LP/FT	28/410	PE
1409	400	165	80	SP/DT/LP/FT	28/410	PET
1413	400	177	40x86	SP/DT/LP/FT	28/410	PET
428	400	175	88	SP/DT/LP/FT	28/410	PET
396	400	184	74	SP/DT/LP/FT	28/410	PE
1511	500	178	53x86	SP/DT/LP/FT	28/410	PET
1514	500	156	60x84	SP/DT/LP/FT	28/400	PET
1515	500	193	46x85	SP/DT/LP/FT	28/400	PET
1994	1000	221	66x95	SP/DT/LP/FT	33/410	PET

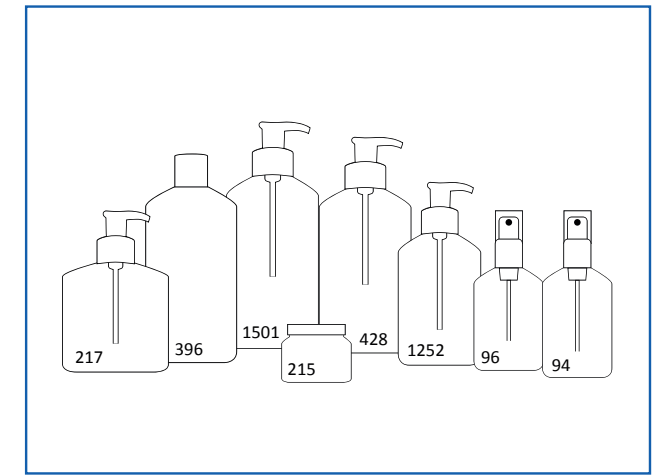

REF	VOL	H mm	D mm	CAP	NECK FINISH	MATERIAL
-----	-----	------	------	-----	-------------	----------

## BOTTLES

1100	100	117	42	LP/SP/DT/FT	24/410	PET
1205	200	148	52	LP/SP/DT/FT	24/410	PET
1255	250	163	55	LP/SP/DT/FT	24/410	PET
1260	250	163	55	LP/SP/DT/FT	28/410	PET
236	250	184	56x39	LP/SP/DT/FT	24/410	PE
289	280	154	61	LP/SP/DT/FT	28/410	PET
1406	400	200	50x60	LP/SP/DT/FT	24/410	PET

## JARS

2250	250	62	92	ST16/ST25/ALU16/ ALU25/D/AL/GAL	89/400	PET
184	250	61	92	ST16/ST25/ALU16/ ALU25/D/AL/GAL	89/400	PP
2352	350	77	92	ST16/ST25/ALU16/ ALU25/D/AL/GAL	89/400	PET
546	500	75	107	ST16/ST25/ALU16/ ALU25/D/AL/GAL	89/400	PE
279	500	87	100	ST18	100/400	PP
331	1000	135	110	sw336	Special	PP



# AROMA

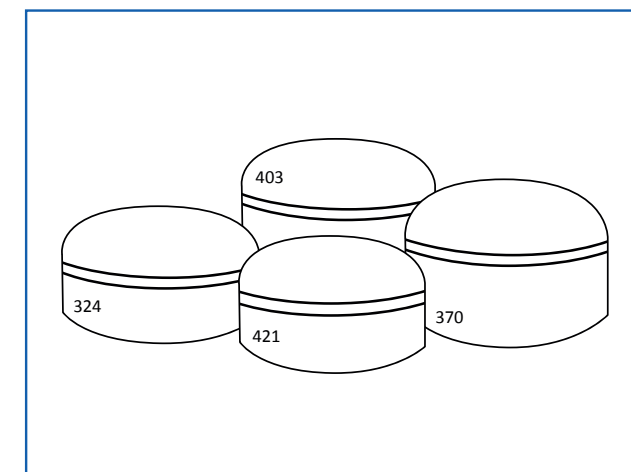

REF	VOL	H mm	D mm	CAP	NECK FINISH	MATERIAL
-----	-----	------	------	-----	-------------	----------

## BOTTLES

421 A	50	38	86	sw419	70/400	HIPS
421 B	60	38	86	sw419	70/400	HIPS
324 A	100	54	93	sw313	83/400	HIPS
324 B	125	54	93	sw313	83/400	HIPS
370	150	66	93	sw159	83/400	HIPS
403	150	67	93	sw159	83/400	HIPS



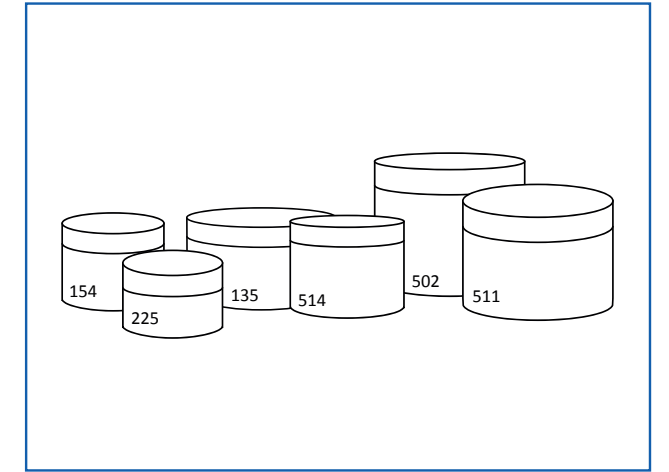

REF	VOL	H mm	D mm	CAP	NECK FINISH	MATERIAL
-----	-----	------	------	-----	-------------	----------

**BOTTLES**

239	30	22	54	ST10	53	PP
225	100	36	72	ST12/ST20/D	70/400	PP
295	120	43	72	ST12/ST20/D	70/400	PP
286	125	47	72	ST12/ST20/D	70/400	PP
154 S	150	51	72	ST12/ST20/D	70/400	PP
186 S	250	60	91	ST16 / ST25	89/400	PP
514	300	64	89	ST16 / ST25	89/400	PP
511	500	95	89	ST16 / ST25	89/400	PP
135 S	500	60	118	ST19	118	PP
502	600	90	100	ST19	100/400	PP
552 M	200	46	89	-	89/400	PP



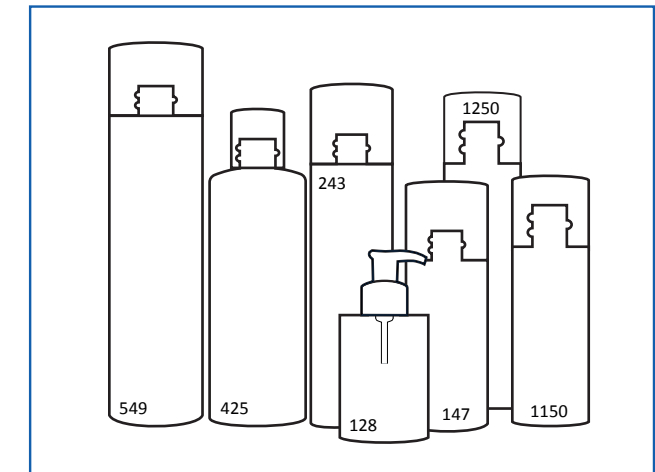

REF	VOL	H mm	D mm	CAP	NECK FINISH	MATERIAL
-----	-----	------	------	-----	-------------	----------

### BOTTLES

128	100	88	48	OV 48/45-55 +SP/DT/LP	24/400 24/ 410 28/400	PE
147	150	110	48	OV 48/45-55 +SP/DT/LP	24/400 24/ 410 28/400	PE
1150	150	95	48	OV 48/45-55 +SP/DT/LP	24/410	PET
1209	200	148	48	OV 48/45-55 +SP/DT/LP	24/410	PET
1250	250	174	48	OV 48/45-55 +SP/DT/LP	24/410	PET
196	200	130	48	OV 48/45-55 +SP/DT/LP	24/410	PE
243	250	180	48	OV 48/45-55 +SP/DT/LP	24/400 24/ 410 28/400	PE
425	400	170	62	OV 62/45 -68 SP/DT/LP	28/410 28/400	PE
549	500	206	62	OV 62/45 -68 SP/DT/LP	28/410 28/400	PE
1036	1000	243	82	OV 62/45 -68 SP/DT/LP	28/410	PE



# NY ALE



REF	VOL	H mm	D mm	CAP	NECK FINISH	MATERIAL
-----	-----	------	------	-----	-------------	----------

## BOTTLES

128	100	88	48	OV Ale +SP/DT/LP	24/400 24/ 410 28/400	PE
147	150	110	48	OV Ale +SP/DT/LP	24/400 24/ 410 28/400	PE
1150	150	95	48	OV Ale +SP/DT/LP	24/410	PET
1209	200	148	48	OV Ale +SP/DT/LP	24/410	PET
196	200	130	48	OV Ale +SP/DT/LP	24/410	PE
243	250	180	48	OV Ale +SP/DT/LP	24/400 24/ 410 28/400	PE
1250	250	174	48	OV Ale +SP/DT/LP	24/410	PET
425	400	206	62	OV Ale +SP/DT/LPP	28/410 28/400	PE
549	400	225	62	OV Ale +SP/DT/LP	28/410 28/400	PE

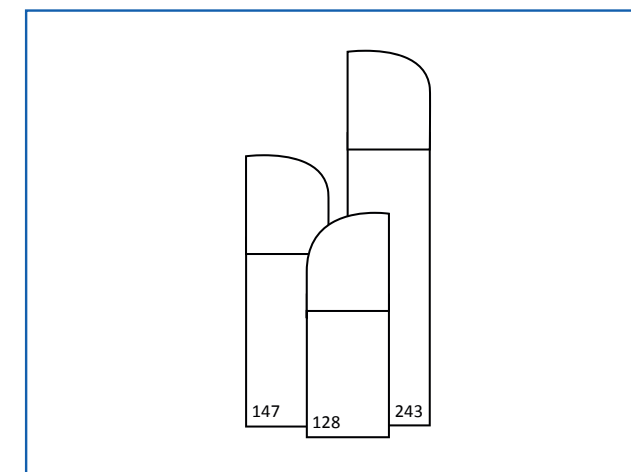

# NYCR

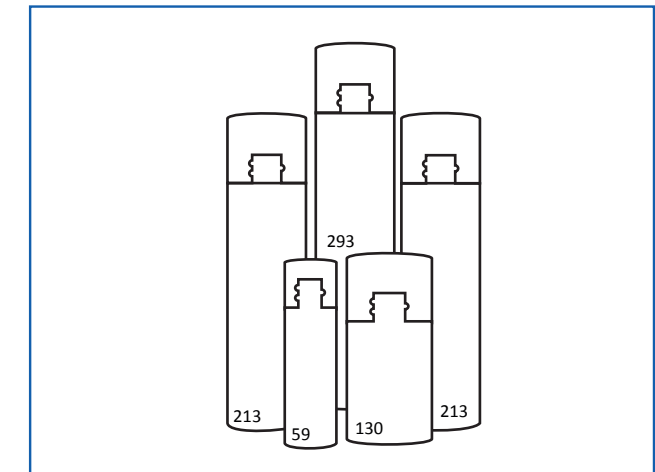

REF	VOL	H mm	D mm	CAP	NECK FINISH	MATERIAL
-----	-----	------	------	-----	-------------	----------

## BOTTLES

59	50	95	30	Special	Special	PE
1060	60	82	39	Special	20/410	PET
130	100	97	48	Special Twist / NYAL	20/410	PE
1120	120	138	39	Special	20/410	PET
213	200	165	48	Special Twist / NYAL	Special	PE
293	250	194	48	Special Twist / NYAL	Special	PE
244	250	185	48	NYAL	24/415	PET

## CAP NYCR

492	-	-	-	-	-	-
-----	---	---	---	---	---	---



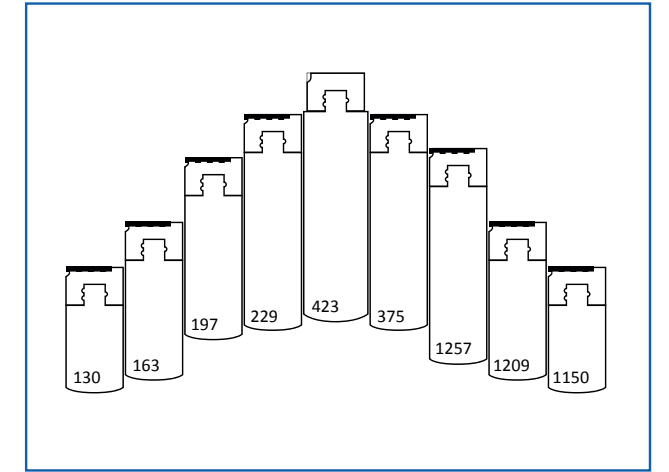

REF	VOL	H mm	D mm	CAP	NECK FINISH	MATERIAL
-----	-----	------	------	-----	-------------	----------

## BOTTLES

130	100	90	48	FTP Flip Top Push NYB	Special Push	PE
163	150	122	48	FTP Flip Top Push NYB	Special Push	PE
1150	150	117	48	FTP Flip Top Push NYB	24/410 - Special Push	PET
190	200	153	48	FTP Flip Top Push NYB	Special Push	HDPE
197	200	155	48	FTP Flip Top Push NYB	Special Push	PE
1209	200	148	48	FTP Flip Top Push NYB	24/410 - Special Push	PET
229	250	183	48	OV 48/45 -55 +SP/DT/LP	Special Push	PE
1257	250	176	48	FTP Flip Top Push NYB	24/410 - Special Push	PET
315	300	210	48	FTP Flip Top Push NYB	Special Push	PE
375	300	176	55	FTP Flip Top Push NYB	Special Push	PE
423	400	206	56	FTP Flip Top Push NYB	Special Push	PE
467	400	155	68	FTP Flip Top Push NYB	Special Push	PE
549 B	500	207	62	FTP Flip Top Push NYB	Special Push	PE
436	400	192	56	Cap 38 mm	Special	PE
1036	1000	244	82	FTP Flip Top Push NYB	Special Push	PE



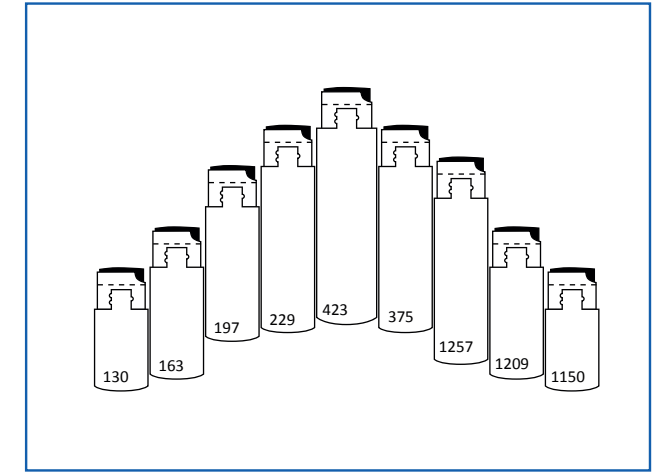

REF	VOL	H mm	D mm	CAP	NECK FINISH	MATERIAL
<b>BOTTLES</b>						
130	100	90	48	DTP Disc Top Push NYD	Special Push	PE
163	150	122	48	DTP Disc Top Push NYD	Special Push	PE
1150	150	117	48	DTP Disc Top Push NYD	24/410 - Special Push	PET
190	200	153	48	FTP Flip Top Push NYD	Special Push	HDPE
197	200	155	48	DTP Disc Top Push NYD	Special Push	PE
1209	200	148	48	DTP Disc Top Push NYD	24/410 - Special Push	PET
229	250	183	48	DTP Disc Top Push NYD	Special Push	PE
1257	250	176	48	DTP Disc Top Push NYD	24/410 - Special Push	PET
315	300	210	48	DTP Disc Top Push NYD	Special Push	PE
375	300	176	55	DTP Disc Top Push NYD	Special Push	PE
423	400	206	56	DTP Disc Top Push NYD	Special Push	PE
467	400	155	68	FTP Flip Top Push NYD	Special Push	PE
549 B	500	207	62	FTP Flip Top Push NYD	Special Push	PE
1036	1000	244	82	FTP Flip Top Push NYD	Special Push	PE



# RD PET

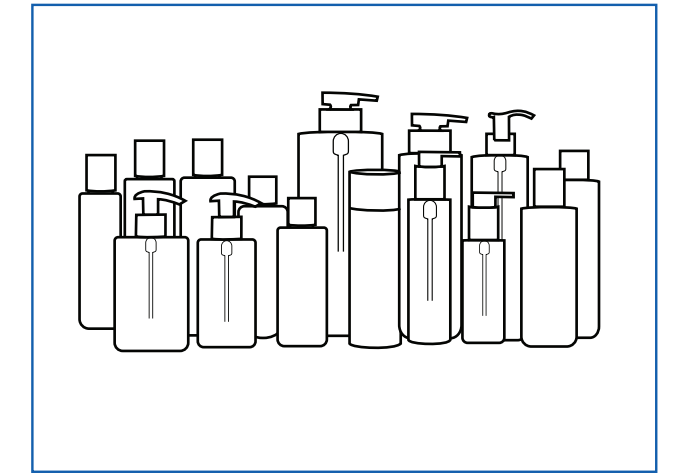

REF	VOL	H mm	D mm	CAP	NECK FINISH	MATERIAL
<b>BOTTLES</b>						
1070	75	105	36	LP/SP/DT /FT	20/410	PET
1102	100	119	39	LP/SP/DT /FT	24/410	PET
1105	100	132	39	LP/SP/DT /FT	24/410	PET
164	150	164	40	SP / LP / R	24/410	PET
1151	150	155	40	SP/DT/LP/FT	24/410	PET
1170	170	137	47	SP/DT/LP/FT	24/410	PET
210	200	120	54	SP/DT/LP/FT	28/410	PETG
1204	190	153	47	SP/DT/LP/FT	24/410	PET
1213	200	156	47	SP/DT/LP/FT	24/410	PET
1208	200	154	47	SP/DT/LP/FT	24/410	PET
244	250	178	48	SP/NYAL/R/LP	24/410	PET
1251	250	148	54	SP/DT/LP/FT	24/410	PET
1254	250	170	48	SP/DT/LP/FT	24/410	PET
309	300	185	52	SP/NYAL/R/LP	24/410	PET
366	300	120	67	SP/DT/LP/FT	28/410	PETG
424	400	207	56	SP/NYAL/R/LP	24/410	PET
1402	400	194	56	SP/NYAL/R/LP	24/410	PET
1504	500	198	63	SP/DT/LP/FT	28/410	PET
1999	1000	217	84	SP/NYAL/R/LP	28/410	PET



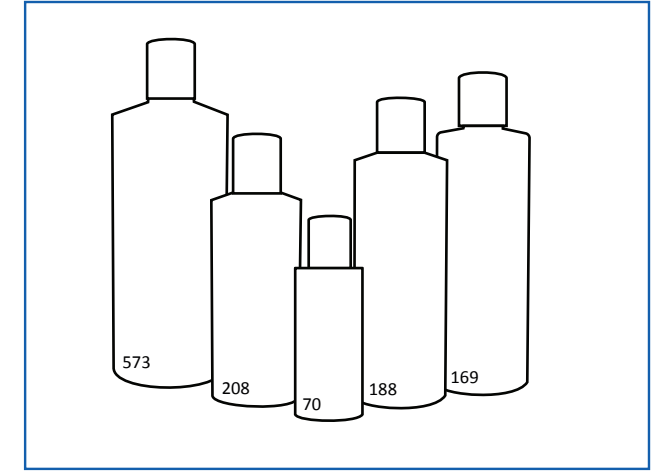

REF	VOL	H mm	D mm	CAP	NECK FINISH	MATERIAL
<b>BOTTLES</b>						
70	70	95	35	LP / FT / DT	20/410	PE
63	75	95	35	LP / FT / DT	20/410	PE
192	200	115	56	LP / FT / DT	32/400	PE
197	200	153	50	LP / FT / DT	24/410	PE
208	200	142	52	LP / FT / DT	24/415	PE
188	250	167	50	LP / FT / DT	24/410	PE
237	250	159	52	LP / FT / DT	24/410	PE
369	300	169	54	LP / FT / DT	24/410	PE
394	400	152	62	LP / FT / DT	28/410	PE
nl	500	201	67	LP / FT / DT	28/410	PE
573	500	200	63	LP / FT / DT	28/410	PE
1035	1000	240	81	LP / FT / DT	28/410	PE
1036	1000	237	82	LP / FT / DT	33/410	PE



# RD-46



REF	VOL	H mm	D mm	CAP	NECK FINISH	MATERIAL
-----	-----	------	------	-----	-------------	----------

## BOTTLES

136	125	108	46	SP/DT/LP/FT	24/410	PE
144	150	124	46	SP/DT/LP/FT	24/410	PE
186	250	189	46	SP/DT/LP/FT	24/410	PE

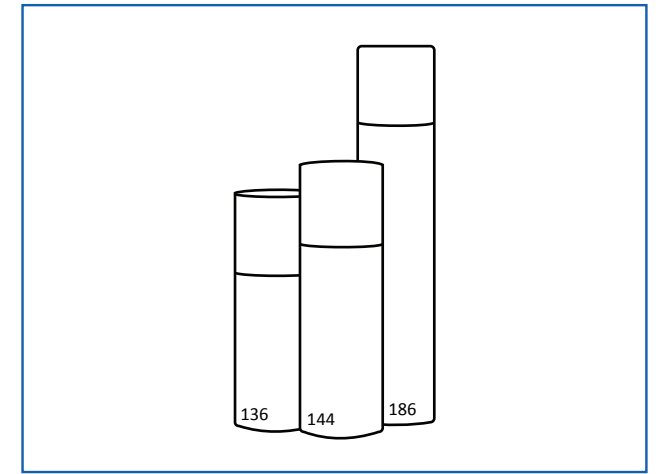

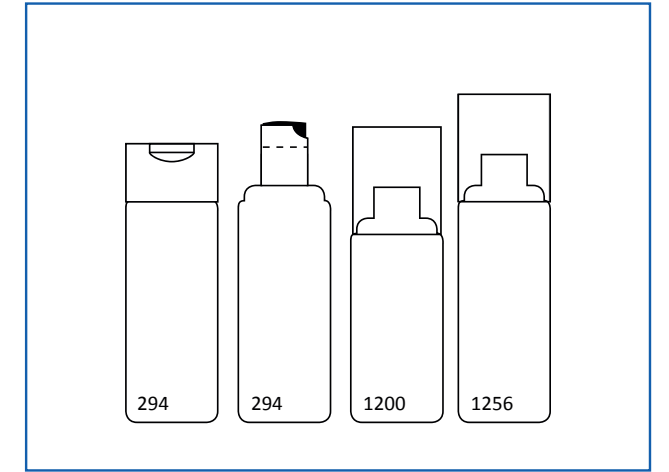

REF	VOL	H mm	D mm	CAP	NECK FINISH	MATERIAL
-----	-----	------	------	-----	-------------	----------

### BOTTLES

294	250	135	48x48	DT LA 531/OV LA 538 SP/DT/LP/FT	Special	PP
1200	200	105	48x48	DT LA 531/OV LA 538 SP/DT/LP/FT	24/410	PET
1256	250	153	48x48	DT LA 531/OV LA 538 SP/DT/LP/FT	24/410	PET



# SAPIR

REF	VOL	H mm	D mm	CAP	NECK FINISH	MATERIAL
-----	-----	------	------	-----	-------------	----------

## BOTTLES

1210	220	145	50	SW525/LP/SP/DT	28/410	PET
1259	250	157	54	SW527/LP/DT	24/410	PET

## JARS

273	50	48	70	SPECIAL	SPECIAL	ACRYLIC
271	50	38	72	ST12/ST20 /D	70/400	PP
518	200	68	92	ST16/ST25/ALU16/ ALU25/AL	89/400	PP
517	250	78	92	ST16/ST25/ALU16/ ALU25/AL	89/400	PP
239	250	67	92	ST16/ST25/ALU16/ ALU25/AL	89/400	PET

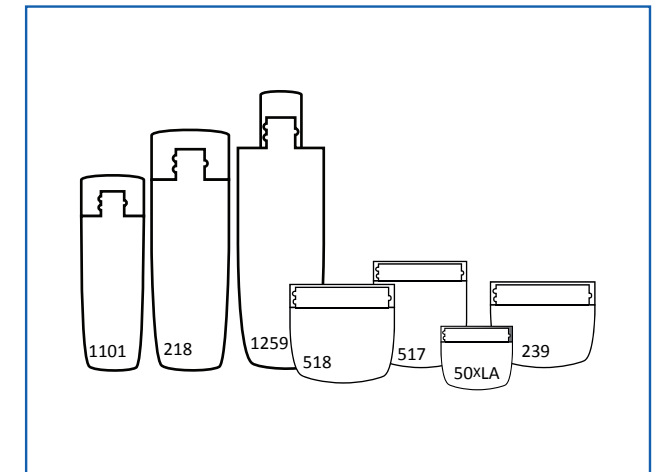

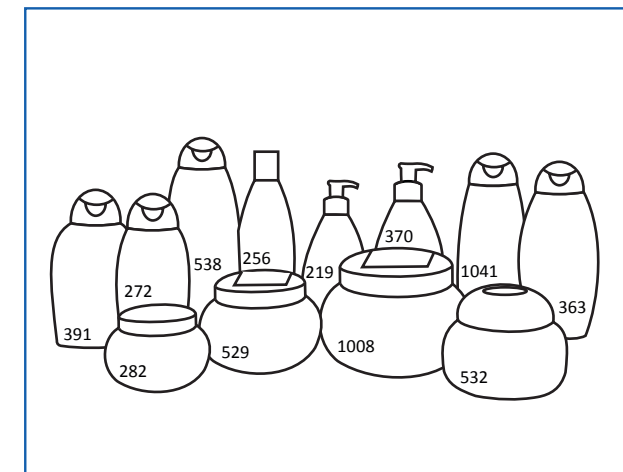

## BOTTLES

REF	VOL	H mm	D mm	CAP	NECK FINISH	MATERIAL
193	200	185	60x40	FT	24/415	PE
219	236	157	74x35	LP/DT/FT/SP	24/410	PP
256	250	205	70	FT	24/415	PE
272	250	171	36x76	wp1010	Special	PE
342	350(12Oz)	180	90x47	PCF 003	Special	PE
363	350	193	90x36	wp1010	Special	PP
370	350	170	47x87	LP/DT/FT/SP	28/410	PP
434	400	185	82x48	LP/DT/FT/SP	28 mm 28/410	PE
391	400	162	99x43	CB	Special28	PP
465	500	177	95x62	LP/DT/FT/SP	28/410	PE
1401	400	177	82.5x45	CB	Pco 28	PET
538	500	230	45x90	wp1010	Special	PE
768	750	222	98x60	LP/DT/FT/SP	28 mm 28/410	PE
1753	750	226	97x60	LP/DT/FT/SP	28/410	PET
1031	1000	263/258	109x61	LP/DT/FT/SP	28mm 28/410	PE

## JARS

532	500	78	99x120	D / GEL	Special	PE
1008	1000	108	125x148	GEL	118/400	PP
282	280	67	72x98	D / ST16	70	PE
529	500	77	94x116	D	Special	PE



# TALIA

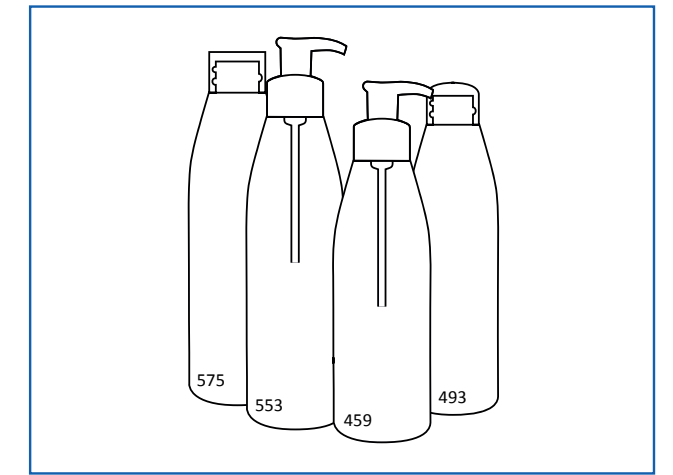

REF	VOL	H mm	D mm	CAP	NECK FINISH	MATERIAL
-----	-----	------	------	-----	-------------	----------

## BOTTLES

62	60	87	38	DT/LP/SP/FT	20/410	PE
145	150	130	46	DT/LP/SP/FT	24/410	PE
1154	150	130	46	DT/LP/SP/FT	24/410	PET
1240	240	166	50	DT/LP/SP/FT	24/410	PET
459	400	190	62	LP	28/410	PE
471	400	190	62	LP	28/410	PE
493	500	213	62	DT	24/410	PE
553	500	230	62	LP	24/410 28/410	PE
575	550	245	62	DS / NYB	24/410	PE
764	1000	233	74	DT/LP/SP/FT	28/410	PE



# BOSTON

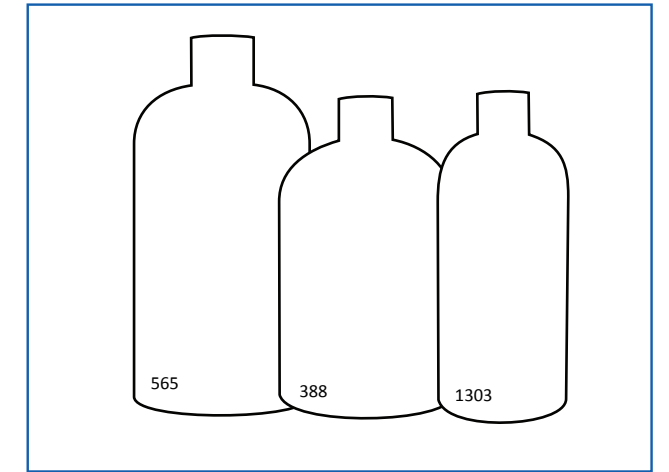

REF	VOL	H mm	D mm	CAP	NECK FINISH	MATERIAL
-----	-----	------	------	-----	-------------	----------

## BOTTLES

334	250	-	-	-	-	-
1266	250	127	60	LP/FT/DT	28/410	PET
301	300	129	62	LP/FT/DT	28/410	PE/PP
319	300	149	59	LP/FT/DT	24/410	PE
337	300	149	59	Delta CB	Special	PE
388	400	134	74	LP/FT/DT	24/410	PE/PP
1305	300	147	58	LP/FT/DT	24/410	PET
1414	400	162	65	LP/SP/DT /FT	28/410	PET
504	500	191	70	0	-	-
565	500	157	75	LP/FT/DT	28/410	PE

## JARS

137	50	-	-	-	70/400	-
510	500	225	90x45	NA	special	-



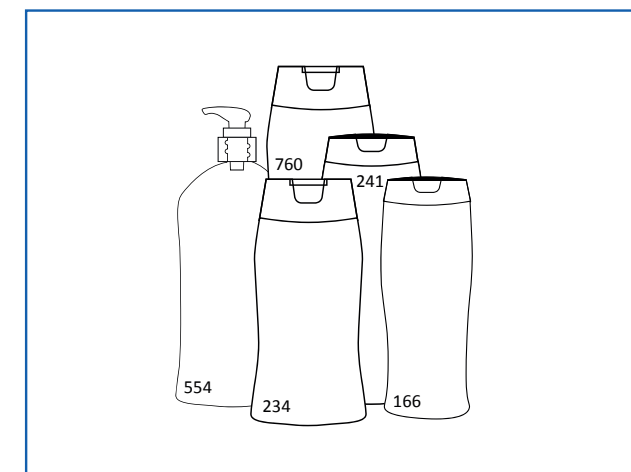

REF	VOL	H mm	D mm	CAP	NECK FINISH	MATERIAL
-----	-----	------	------	-----	-------------	----------

## BOTTLES

166	150	140	62	Special	Special	PP / PE
234	200	141	68	EC 6	Special	PE
241	250	165	67	Special	Special	PP / PE
554	500	177	84	LP / DT	28/410	PE
760	750	228	89	SW510	Special	PE





REF	VOL	H mm	D mm	CAP	NECK FINISH	MATERIAL
-----	-----	------	------	-----	-------------	----------

## BOTTLES

1203	200	151	65x36	LP/SP/DT/FT	24/410	PET
189	250	176	69x39	LP/SP/DT/FT	24/410 Special	PE
1404	400	167	73	LP/SP/DT/FT	28/410	PET
1751	750	222	90	Cap Zeus	29/21	PET
1754	750	229	90	LP/SP/DT/FT	28/410	PET



# CLAUDIA

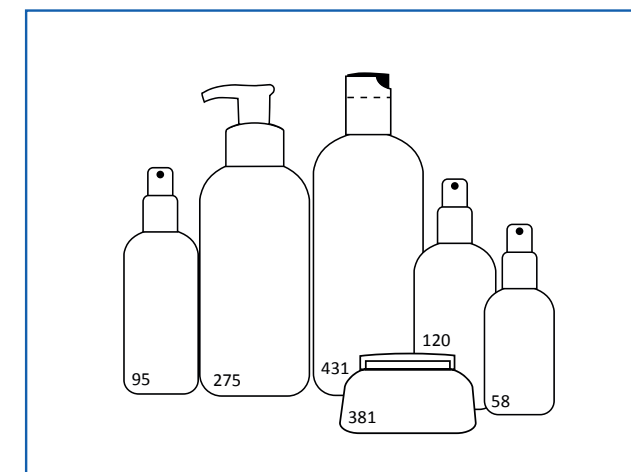

REF	VOL	H mm	D mm	CAP	NECK FINISH	MATERIAL
-----	-----	------	------	-----	-------------	----------

## BOTTLES

58	60	105	41x28	DT/SP/LP	20/415	PET
95	100	117	48x33	DT/SP/LP	20/415	PVC
120	110	115	47x32	DT/SP/LP	20/415	PET
1110	110	115	48x33	DT/SP/LP	20/415	PET
275	250	184	68x36	DT/SP/LP	24/415	PE
431	400	200	80x50	ST/LP/DT/FT	24/415	PE

## JAR

381	50	43	67x80	ST16	53	PP
-----	----	----	-------	------	----	----



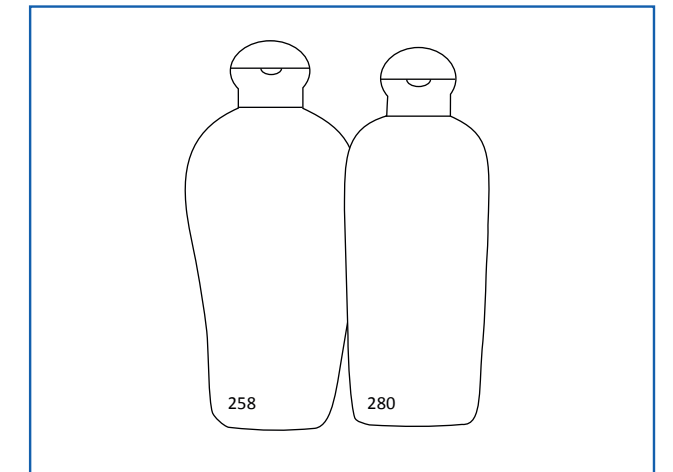

REF	VOL	H mm	D mm	CAP	NECK FINISH	MATERIAL
-----	-----	------	------	-----	-------------	----------

## BOTTLES

116	120	141	32x58	wp1208	Special	PE
258	250	183	30x82	wp1208	Special	PE
280 A	280	163	43x69	LP	28/400 28/410	PE
280 B	280	180	43x69	wp1208	Special	PE
404	400	192	48x82	wp1208	Special	PE
1415	400	183	51x75	SP/DT/LP/FT	28/410	PET



# AGAS

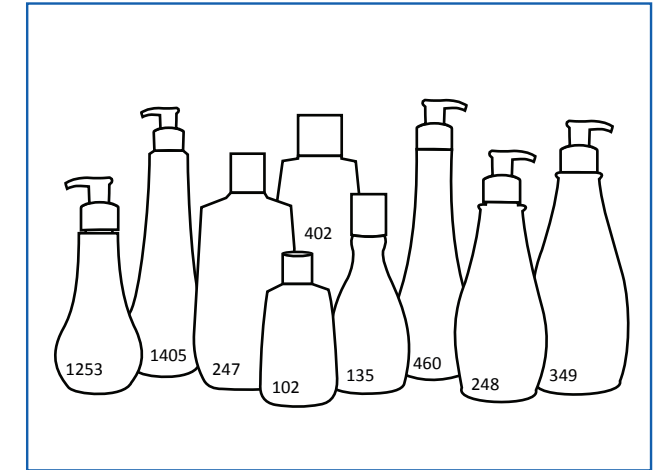

REF	VOL	H mm	D mm	CAP	NECK FINISH	MATERIAL
-----	-----	------	------	-----	-------------	----------

## BOTTLES

102	100	119	30x60	15	Special	PE
135	150	156	68x37	LP/DT/FT	24/415	PE
247	250	189	65x53	LP/DT/FT	24/410	PP
248	250	174	74x42	LP/DT/FT	28/410	PVC
1253	250	155	35x80	LP/DT/FT	24/410	PET
349	350	198	40x88	LP/DT/FT	28/410	PE
402	400	190	45x86	70	Special	PE
1405	400	210	35x83	LP/DT/FT	28/410	PET
460	400	214	81	SP/DT/LP	28/410	PVC
510	500	225	90x45	NA	Special	PE
1001	1000	254	55x106	sw42	Special	PE



# DIANA

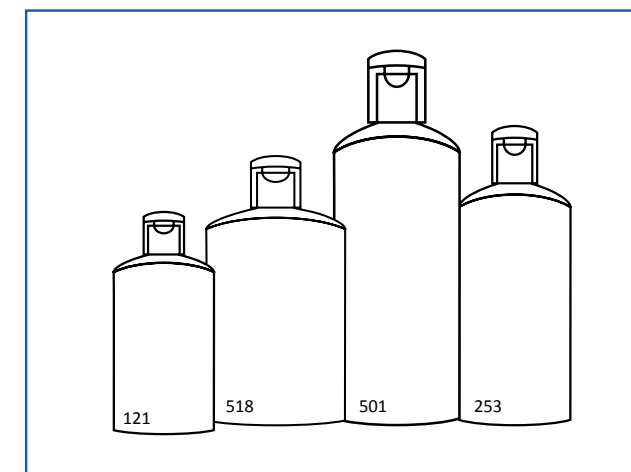

REF	VOL	H mm	D mm	CAP	NECK FINISH	MATERIAL
-----	-----	------	------	-----	-------------	----------

## BOTTLES

121	100	114	56x27	LP/DT/FT	20/410	PE
123	110	116	56x31	LP/DT/FT	20/410	PE
253	250	179	37x71	70	Special	PP
501	500	240	45x87	70	Special	PP
518	500	141	71x85	LP	28/410	PP



# PRO V

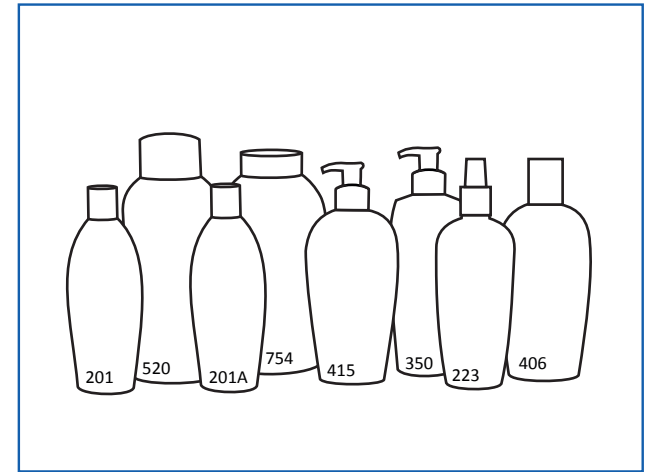

REF	VOL	H mm	D mm	CAP	NECK FINISH	MATERIAL
-----	-----	------	------	-----	-------------	----------

## BOTTLES

201	200	177	36x66	FT	24/410	PVC
201A	200	177	36x66	DT/LP	24/410	PP
223	250	182	38x70	Snap	-	PE
350	350	180	42x77	DT/LP	28/410	PE
406	400	181	45x84	Coster 233	28/410	PVC
415	400	181	45x84	LP	28/410	PE
516	500	234	45x89	FT 800	Special	PP/PE
519	500	-	-	P 1000	28/400	PE
520	500	235	45x88	wp1001	Special	PE
522	500	147	67x90	LP	28/400	PE
526	500	-	-	Zeller	Special	PE
754	750	214	59x 103	WP1104	Special	PE



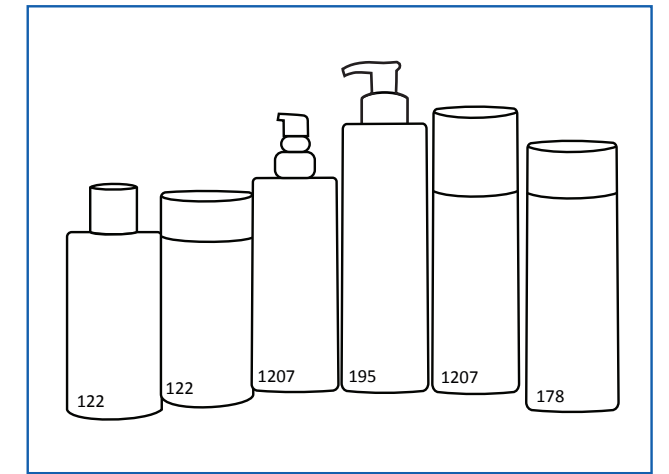

REF	VOL	H mm	D mm	CAP	NECK FINISH	MATERIAL
-----	-----	------	------	-----	-------------	----------

**BOTTLES**

122	150	131	55x39	Overcap OVAL 55x 39+LP/SP/ DT/FT +FT Oval	24/410	PE
178	200	164	55x39	Overcap OVAL 55x 39+LP/SP/ DT/FT +FT Oval	24/410	PE
195	250	195	55x39	Overcap OVAL 55x 39+LP/SP/ DT/FT +FT Oval	24/410	PE
1207	200	161	55x39	Overcap OVAL 55x 39+LP/SP/ DT/FT +FT Oval	28/410	PET



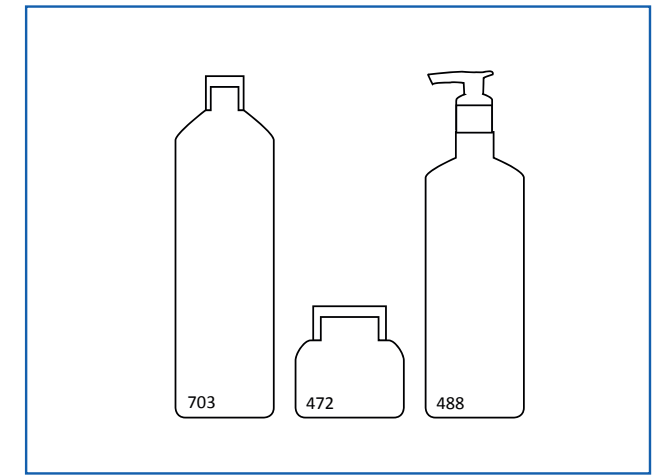

REF	VOL	H mm	D mm	CAP	NECK FINISH	MATERIAL
-----	-----	------	------	-----	-------------	----------

## BOTTLES

488	500	200	59x59	LP/DP/SP/FT	28/410	PE
703	700	225	64x64	Disc Push DT 254	Special	PE

## JAR

472	500	86	96x96	ST16/ST25/D/GAL /CARMIT	89/400	PE
577	550	84	97x97	ST16/ST25/D/GAL /CARMIT	89/400	PE



# SMADAR

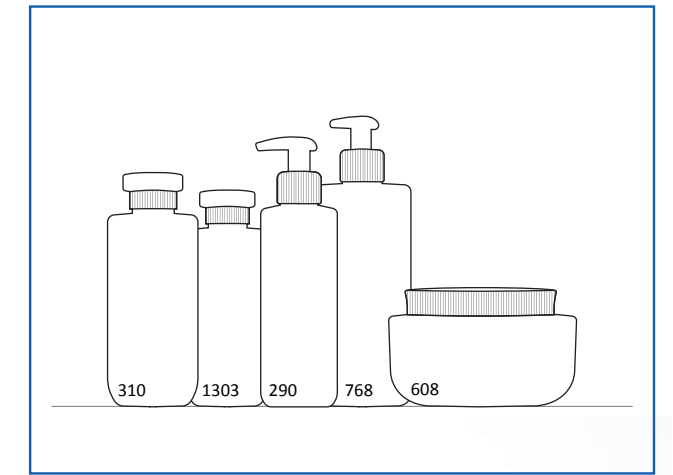

REF	VOL	H mm	D mm	CAP	NECK FINISH	MATERIAL
-----	-----	------	------	-----	-------------	----------

## BOTTLES

290	250	156	52	SP / DT / LP	28/410	PE
310	300	147	60	SP / DT / LP	28/410	PE
1303	300	145	60	SP / DT / LP	28/410	PET
468	500	174	71	SP / DT / LP	28/410	PE
770	750	270	67	DT/FT/LP/SP + ST Special 618	28/410	PE

## JARS

608	500	70	116	ST16/ST25 /D/GAL	89/400	PE
2302	350	67	94	ST16/ST25 /D/GAL	89/400	PET



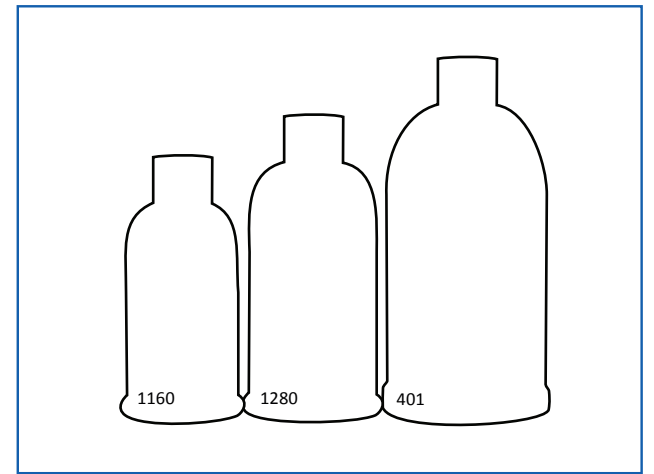

REF	VOL	H mm	D mm	CAP	NECK FINISH	MATERIAL
-----	-----	------	------	-----	-------------	----------

## BOTTLES

1104	100	100	47	SP/DT/LP/FT	24/410	PET
1160	160	117	54	SP/DT/LP/FT	24/410	PET
1280	280	140	58	SP/DT/LP/FT	24/410	PET
1300	300	140	60	SP/DT/LP/FT	24/410	PET
401	450	-	-	sw42	-	-



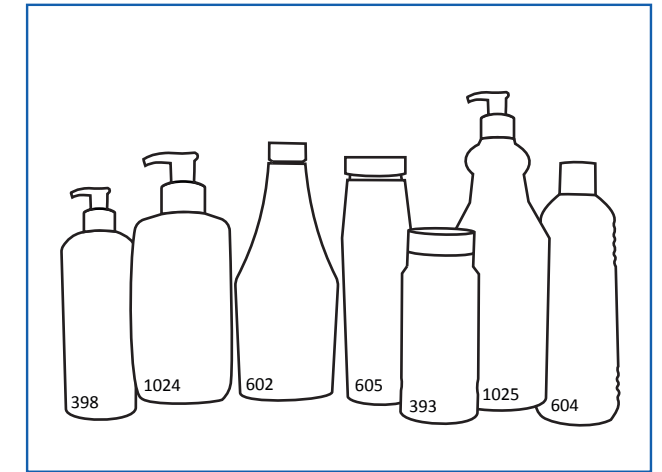

REF	VOL	H mm	D mm	CAP	NECK FINISH	MATERIAL
-----	-----	------	------	-----	-------------	----------

## BOTTLES

393	400	170	70	Special	Special	PE
398	400	183	64	SP/DT/LP	28/410	PE
602	600	241	97x51	Special	Special	PE
603	600	258	69	Special	Special	PE
604	650	222	75	SP/DT/LP	28/410	PE
605	650	227	64	Special	Special	PE
1003	1000	290	76	SP/DT/LP	28/410	PE
1011	1000	72	154	Special	Special	PE
1023	1000	-	-	-	-	-
1024	1000	200	87x87	SP/DT/LP	38/410	PE
1025	1000	274	83	ST/LP/DT/FT	28/410	PE



# SPECIAL 1-200



REF	VOL	H mm	D mm	CAP	NECK FINISH	MATERIAL
<b>BOTTLES</b>						
93	120	115	65	LP/SP/DT/FT	24/415	PE
106	125	127	71x37	WP1002 WEENER		
133	125	155	67x30	Special	Special	PE
167	150	129	60	SP / DT / LP / FT	24/410	PETG
168	150	105	105x36	Special	Special	PE
160	170	177	60x44	Special + Overcap	Special	PVC
105	200			Crim 15	Special	PE
199	200	127	71x37	Control cap Tecnoplast		
203	200	140	77x36	wp1005	Special	
204	200					PVC
207	200	176	46	crim 20	Special	PE
209	200	171	80x30	Maplast	Special	PE
216	200	148	60	GP	Special	PE
231	200	171	55x37	ST/LP/DT/FT	24/410	PP
1206	200	141	73x34	LP/DT/FT/SP	28/410	PET
262	250			WP1002 WEENER		
214	260	170	42x42	Pco 28 / Overcap	Pco 28	PETG



# SPECIAL 201-500

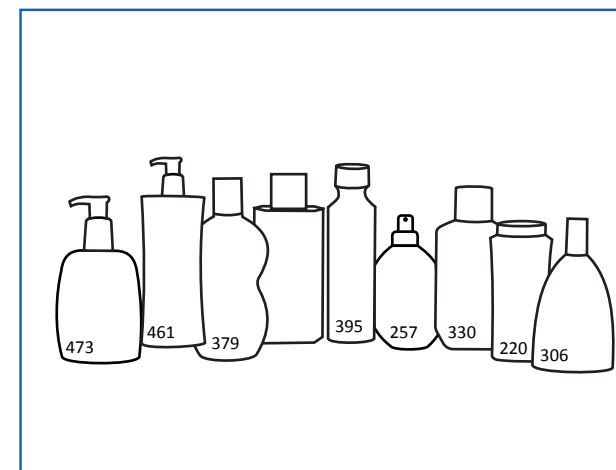

REF	VOL	H mm	D mm	CAP	NECK FINISH	MATERIAL
-----	-----	------	------	-----	-------------	----------

## BOTTLES

222	220	176	50x70	FT Pert Cap	Special	PP
220	250	156	80x40	Special	Special	-
233	250	-	-	-	-	PET
288	250	-	-	GIFLOR(Crema)	-	-
298	250	-	-	-	-	-
257	250	127	96	ST/LP/DT/FT	28/400	-
306	300	169	43x89	Bell	Special	PE
398	300	184	63x54	SW 450	Special	PE
329	300	222	40x65	DT/FT/LP/SP	24/410	PE
264b	300	-	-	ST/LP/DT/FT + Mushroom Sanwa	28/410	-
330	330	185	39x90	Maplast	Special	-
361	350	-	-	24/415	-	PVC
355	350	-	-	Capsol	-	PE
352	350	-	-	-	-	PE
302	350	160	80x40	ST/LP/DT/FT	24/410	PE
379	380	205	90x36	Mantin	28/145	-
451	400	-	-	Sanwa Mushroom	Special	PE
461	400	199	44x86	ST/LP/DT/FT	24/410	PE
395	400	210	55x45	CB Square	Special	PE
413	400	215	45x69	Wp1005	18/410	-
450	450	201	83x42	Snap Square Sanwa	Special	PP
401	450	-	-	sw42	-	-
473	473	163	100	ST/LP/DT/FT	24/415	PE



REF	VOL	H mm	D mm	CAP	NECK FINISH	MATERIAL
494	500	-	-	-	63/400	PET
491	500	-	-	-	-	PET
296	-	-	-	-	-	-
429	-	-	-	Special	18/410	PE

FOR CAPS AND CLOSURES PLEASE TURN TO PAGE 70

# SPECIAL 501-1000

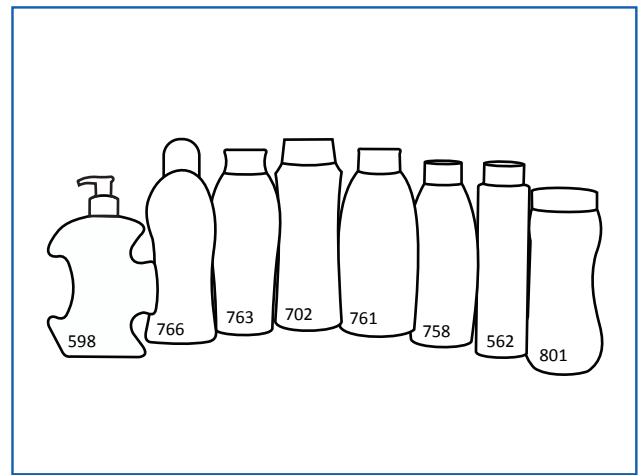

REF	VOL	H mm	D mm	CAP	NECK FINISH	MATERIAL
<b>BOTTLES</b>						
502	500	155	74	LP	24/410	PE
506	500	224	88x41	Snap Square Sanwa	Special	PP
508	500	239	79x50	Yacum 70	Special	PE
527	500	-	-	-	-	-
528	500	86	106	ST15/D 454 /AL	83/400	PE
562	500	227	50x62	Lumson Cap	Special	-
598	750	185	135	ST/LP/DT/FT	28/410	PE
702	700	247	57x87	SW 510	Special	PE
758	750	225	69x75	NYB Push	Special	PE
761	750	230	96	CB	Pco 28	PE
763	750	232	77	CB	Pco 28	PE
766	750	-	-	Special	Special	PE
801	750	-	-	-	70/400	-
900	900	269	66x119	LP / TR	28/410	PE



# ONE LITER



REF	VOL	H mm	D mm	CAP	NECK FINISH	MATERIAL
-----	-----	------	------	-----	-------------	----------

## BOTTLES

1002	1000	266	105	CB	special	PE
1006	1000	275	100	WP1001	special	PE
1009	1000	262	100	WP1001	special	PE
1013	1000	285	75	SP/DT/LP	28/410	PE

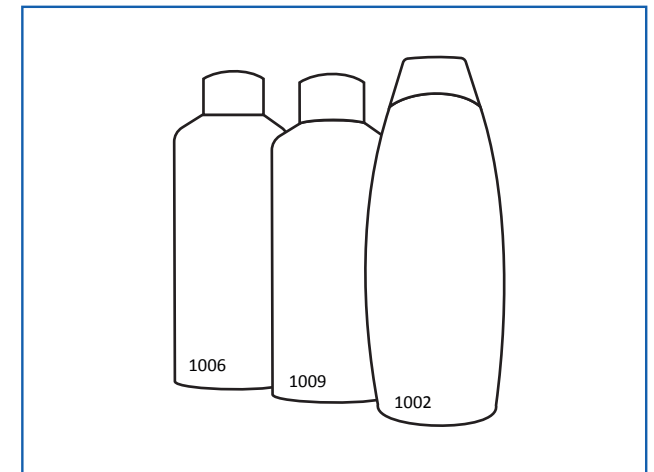

# MG



REF	VOL	H mm	D mm	CAP	NECK FINISH	MATERIAL
-----	-----	------	------	-----	-------------	----------

## BOTTLES

432	400	196	45x77	CB Zeus	special	PE
704	750	245	56x86	CB Zeus	special	PE

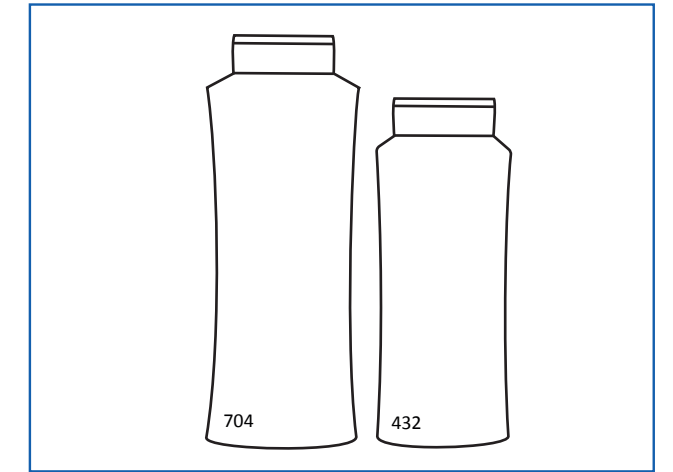

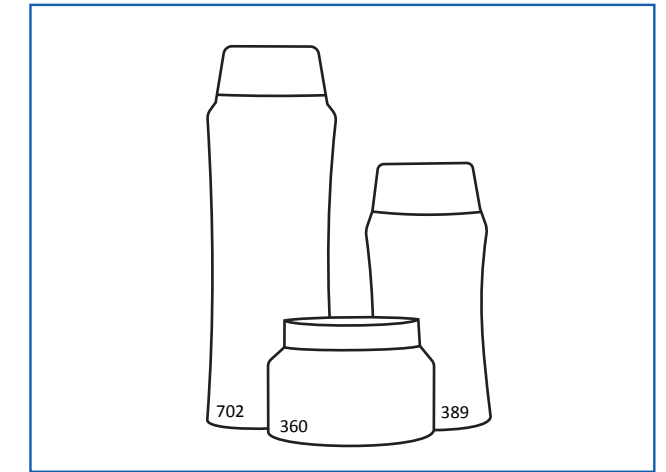

REF	VOL	H mm	D mm	CAP	NECK FINISH	MATERIAL
-----	-----	------	------	-----	-------------	----------

## BOTTLES

389	350	167	47x81	FT 510	special	PE
702	700	245	56x86	FT 510	special	PE

## JAR

360	350	71	90x105	ST/AL(Plastic)	83/400	PP
-----	-----	----	--------	----------------	--------	----



REF	VOL	H mm	D mm	CAP	NECK FINISH	MATERIAL
-----	-----	------	------	-----	-------------	----------

### BOTTLES

1249	250	120	69	DT/FT/LP/SP	24/410	PET
------	-----	-----	----	-------------	--------	-----

### JAR

2253	250	52	97	ST/D/AL (plastic)/ALU	89/400	PET
------	-----	----	----	--------------------------	--------	-----

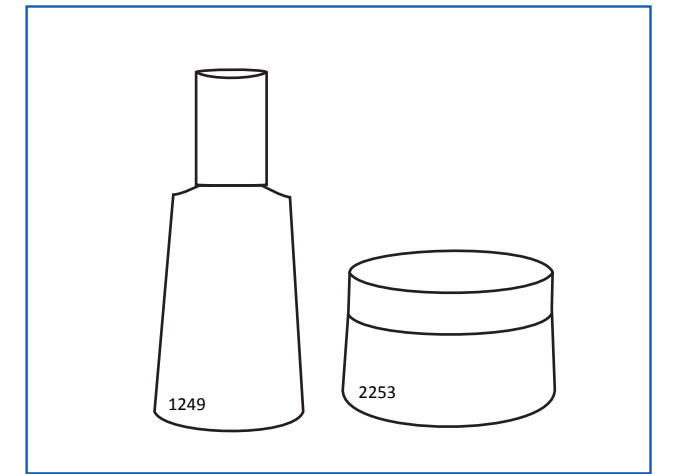

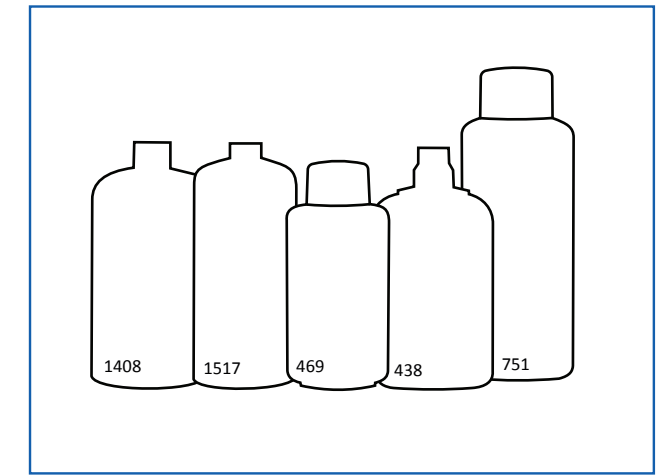

REF	VOL	H mm	D mm	CAP	NECK FINISH	MATERIAL
-----	-----	------	------	-----	-------------	----------

## BOTTLES

1261	250	145	42x70	DT/FT/LP/SP	28/ 410	PET
452	400	185	45x90	wp1001	Special	PE/PP
1408	400	165	84x46	DT/FT/LP/SP	28/410	PET
438	400	164	89x46	DT/FT/LP/SP	28/410	PE
469	500	183	50x94	DT/FT/LP/SP	28/410+Special	PE
1517	500	175	50x92	DT/FT/LP/SP	28/410	PET
751	750	235	54x88	wp1001	Special	PE



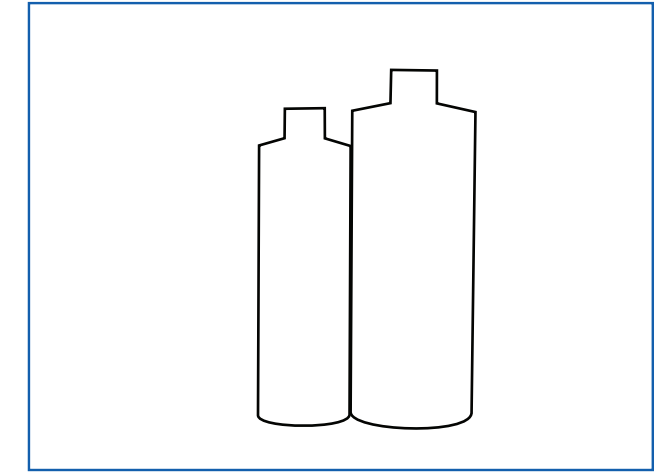

REF	VOL	H mm	D mm	CAP	NECK FINISH	MATERIAL
-----	-----	------	------	-----	-------------	----------

**BOTTLES**

173	250	123	61	DT/FT/LP/SP	28/410	PE
175	250	158	52	DT/FT/LP/SP	24/410	PE
316	300	133	62	DT/FT/LP/SP	28/400 28/410	PE
439	400	170	63	DT/FT/LP/SP	28/410	PE
566	500	103	96	DT/FT/LP/SP	33/410	PE
579	500	189	67	DT/FT/LP/SP	28/410	PE
579	500	185	67	DT/FT/LP/SP	33/400	PE
1036	1000	237	82	DT/FT/LP	33/410 28/410	PE



# BALLS

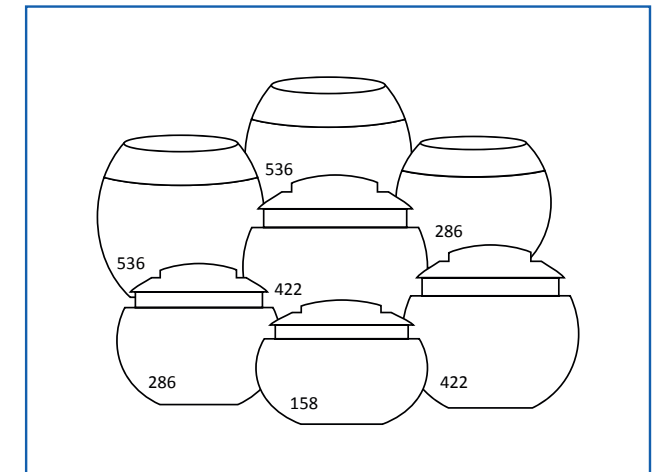

REF	VOL	H mm	D mm	CAP	NECK FINISH	MATERIAL
158	150	50	100	sw388/430	Special	PP
158-397 / 98	3x20	50	100	sw388/430	Special	PP
286	250	69	100	sw388/430	Special	PP
2300	300	77	90	Special	Special	PET
422	400	78	106	sw388/430	Special	PP/PVC
536	500	88	110	sw388/430	Special	PP/PVC



FOR CAPS AND CLOSURES PLEASE TURN TO PAGE 70



Parco-Pack GmbH, D-78467 Konstanz  
+49-7531-81'85'30 – Office@parco-pack.de



REF	VOL	H mm	D mm	CAP	NECK FINISH	MATERIAL
-----	-----	------	------	-----	-------------	----------

## BOTTLES

483	50	28	68	SW484	Special	PP
217	100	45	70	SW312 - D316	Special	PP
425	125	70	57	ST13/ST21/D/ AL/ALU18/R3	58/400	PP
117	150	69	69	SW312 - D 316	Special	PP
141	150	60	71	SW312 - D 316	70/400	PE
175	175	90	52	ST13/ST21/D/ AL/ALU18/R3	58/400	PPTG
251	250	93	69	SW312 -316	Special	PP

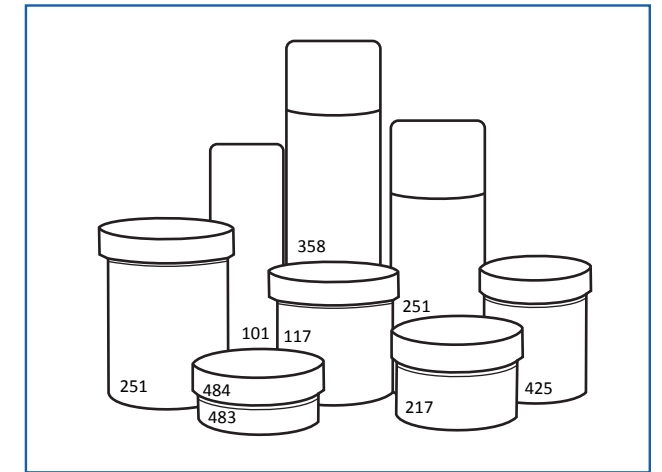

# INBAR



REF	VOL	H mm	D mm	CAP	NECK FINISH	MATERIAL
-----	-----	------	------	-----	-------------	----------

## BOTTLES

1400	400	157	65	LP / FT	28/410	PET
1750	750	210	80	LP / FT	28/410	PET
1998	1000	230	85	LP / FT	28/410	PET

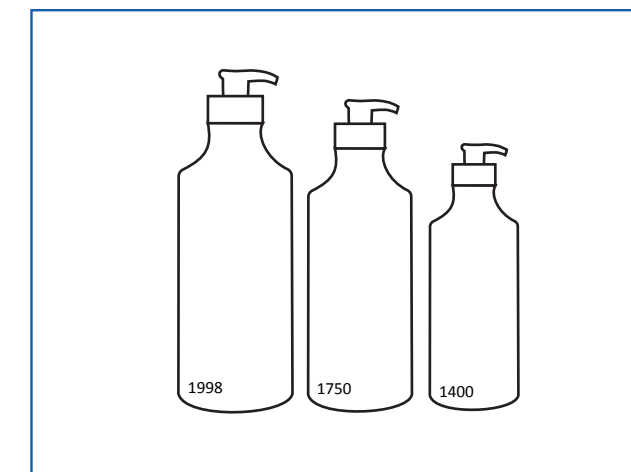

# GEL

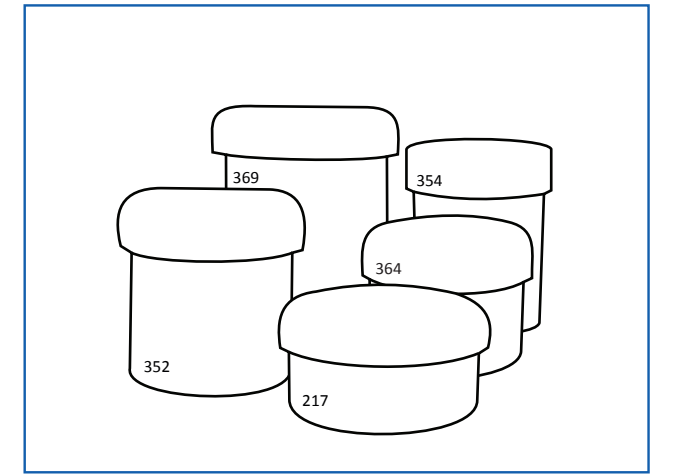

REF	VOL	H mm	D mm	CAP	NECK FINISH	MATERIAL
-----	-----	------	------	-----	-------------	----------

## BOTTLES

217	200	53	93	D / ST16 / AL	89/400	PP
364	300	72	93	D/ST16/AL / GEL SW519	89/400	PP
352	400	82	91	GEL SW363	Special	PP
519	400	112	93	D/ST16/AL / GEL SW519	89/400	PP
354	500	100	91	GEL SW363	Special	PP
221	500	103	92	D/ST16/AL / GEL SW519	89/400	PP
369	1000	142	108	ST19/D/GEL SW359/ SW495	118	PP



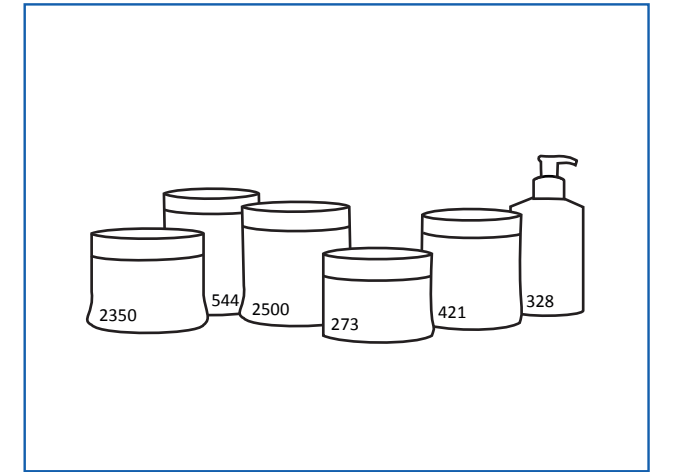

REF	VOL	H mm	D mm	CAP	NECK FINISH	MATERIAL
-----	-----	------	------	-----	-------------	----------

### BOTTLES

328	300	118	55	LP	28 / 410	PP
-----	-----	-----	----	----	----------	----

### JARS

273	250	62	67	AL / D	83/400	PP
2350	350	72	91	ST16/ST25/AL/R3/ ALU16/ALU25/D/GAL	89/400	PP
421	400	88	98	AL / D	83/400	PET
544	400	100	91	AL / D	83/400	PVC
2500	500	95	98	ST16/ST25/AL/R3/ ALU16/ALU25/D/GAL	89/400	PET





REF	VOL	H mm	D mm	CAP	NECK FINISH	MATERIAL
-----	-----	------	------	-----	-------------	----------

## BOTTLES

128	100	88	48	Ring RCO 48/13 +SP/DT/LP	24/410	PE
147	150	110	48	Ring RCO 48/13 +SP/DT/LP	24/410	PE
1150	150	95	48	Ring RCO 48/13 +SP/DT/LP	24/410	PET
1209	200	148	48	Ring RCO 48/13 +SP/DT/LP	24/410	PET
1250	250	174	48	Ring RCO 48/13 +SP/DT/LP	24/410	PET
196	200	130	48	Ring RCO 48/13 +SP/DT/LP	24/410	PE
243	250	180	48	Ring RCO 48/13 +SP/DT/LP	24/410	PE

## JARS

-	30	-	-	ST13/ST21/D/AL /ALU18/R3	58/400	PE
259	50	52	72	ST13/ST21/D/AL /ALU18/R3	58/400	PE
263	100	52	82	ST12/ST20 /D/GAL	70/400	PE
2354	350	63	100	D/ST16/AL/NYJ+new STF ST 18 ref 240	89/400	PET

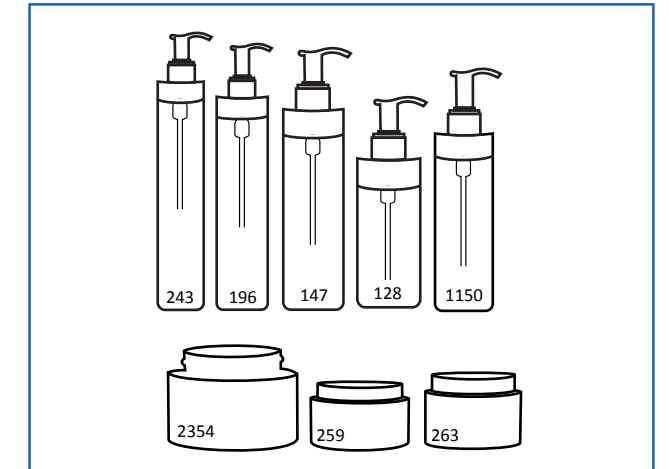



REF	VOL	H mm	D mm	CAP	NECK FINISH	MATERIAL
-----	-----	------	------	-----	-------------	----------

## BOTTLES

1263	250	145	57	LP/SP/DT /FT	28/410	PET
1331	330	155	62	LP/SP/DT /FT	28/410	PET
1512	500	171	72	LP/SP/DT /FT	28/410	PET
1755	750	202	79	LP/SP/DT /FT	33/410	PET
1996	1000	222	90	LP/SP/DT /FT	28/410	PET

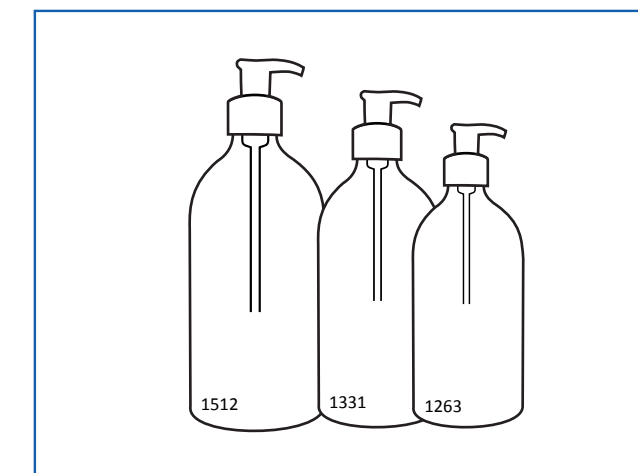



REF	VOL	H mm	D mm	CAP	NECK FINISH	MATERIAL
-----	-----	------	------	-----	-------------	----------

**BOTTLES**

321	300	164	60	DTP Disc Top Push /FTP Flip Top Push	Special Push	PE
489	500	195	69	LP/SP/DT/FT	28/410	PE
563	500	208	64	DTP Disc Top Push /FTP Flip Top Push	Special Push	PE
769	750	222	86	LP	33/410	PE
1032	1000	235	86	LP	33/410	PE



# CARMIT

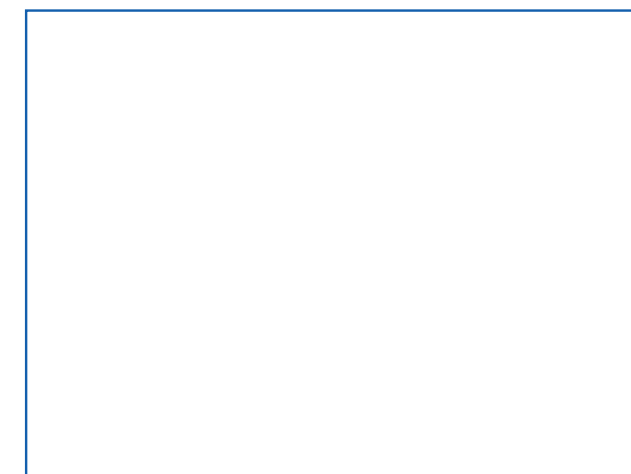

REF	VOL	H mm	D mm	CAP	NECK FINISH	MATERIAL
-----	-----	------	------	-----	-------------	----------

## BOTTLES

180	180	156	55	LP+OV 328	28/410	PP
181	180	126	55	CARMIT 320	Special	PP
226	200	175	47	LP/DT/SP	24/415	PE
283	280	197	55	LP+OV 328	28/410 24/410	PP
284	280	167	55	CARMIT 320	Special	PP

## JARS

306-329	30	43	55	CARMIT 320	Special	PP
340-329	50	56	55	CARMIT 320	Special	PP
306-326	30	43	63	CARMIT 320	Special	PP
340-326	50	56	63	CARMIT 320	Special	PP
214-246	50	46	60	ST13/ST21/D/ AL/ALU18/R3	58/400	PP



# BOTANIC



REF	VOL	H mm	D mm	CAP	NECK FINISH	MATERIAL
-----	-----	------	------	-----	-------------	----------

## BOTTLES

227	200	182	48	LP	24/410	PP
534	500	204	69	LP	28/410	PP

## JARS

309	150	68	80	D Pro Botanic 310	Special	PP
226	250	82	95	D Pro Botanic 310	Special	PP
550	500	100	107x100	ST16	89/400	PP



# AMIGOS

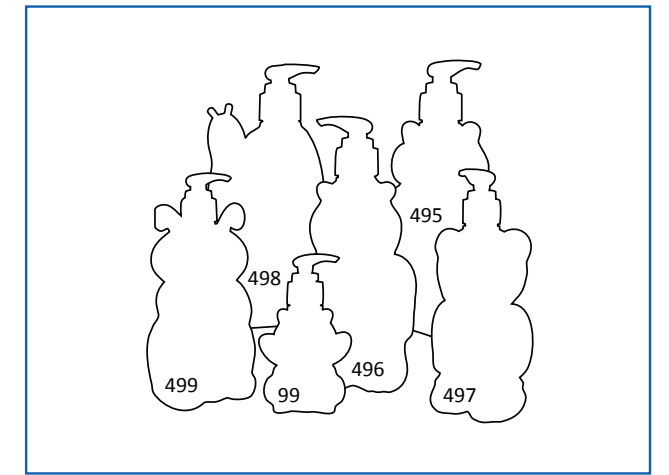

REF	VOL	H mm	D mm	CAP	NECK FINISH	MATERIAL
-----	-----	------	------	-----	-------------	----------

## BOTTLES

99	110	96	53	LP	24/410	PE
497	380	152	79	LP	24/410	PE
496	390	149	78	LP	24/410	PE
495	420	152	80	LP	24/410	PE
498	420	150	81	LP	24/410	PE
499	460	152	84	LP	24/410	PE



# ROLL ON

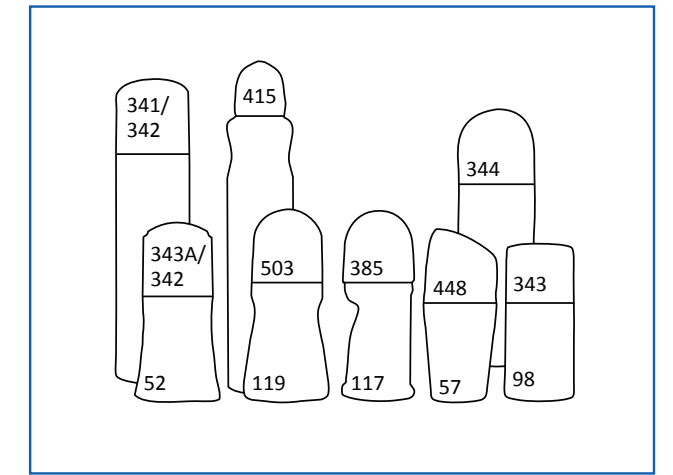

REF	VOL	H mm	D mm	CAP	NECK FINISH	MATERIAL
<b>BOTTLES</b>						
52	70	111	52x32	ROLL ON -343 A	Special	PE
57	70	116	48	ROLL ON -448	Special	PP
91	90	101	40x48	ROLL ON Cream -412	Special	PP
117	90	128	51x50	ROLL ON-385	Special	PP
119	90	130	57x44	ROLL ON -503	Special	PP
98	100	76	48	ROLL ON-343	Special	PP
61	90	114	57x44	ROLL ON -503	Special	PP

<b>CAPS</b>						
341/342		48	46			PP
343		38	47			PP
344		37	53			PP
385		46	47			PP
415		30	34			PP
448		50	47			PP
503		47	47			PP



FOR CAPS AND CLOSURES PLEASE TURN TO PAGE 70



Parco-Pack GmbH, D-78467 Konstanz  
+49-7531-81'85'30 – Office@parco-pack.de

# CANDELA

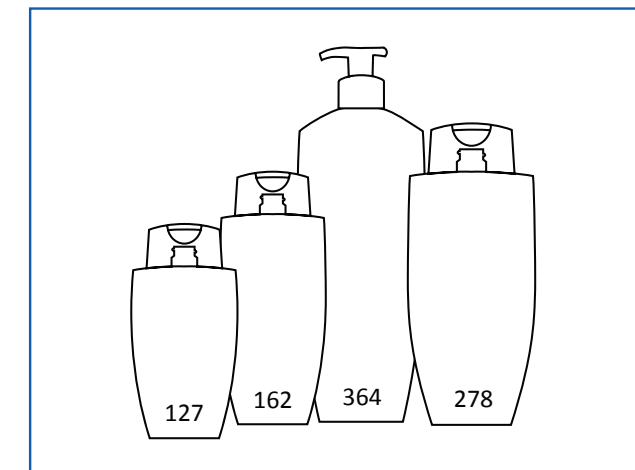

REF	VOL	H mm	D mm	CAP	NECK FINISH	MATERIAL
-----	-----	------	------	-----	-------------	----------

## BOTTLES

127	100	121	62x34	WP1005	Special	PE/PP
162	150	154	62x34	WP1005	Special	PE/PP
278	250	175	73x40	WP1005	Special	PE/PP
364	350	195	79x44	LP	28/410	PE/PP



# GALI

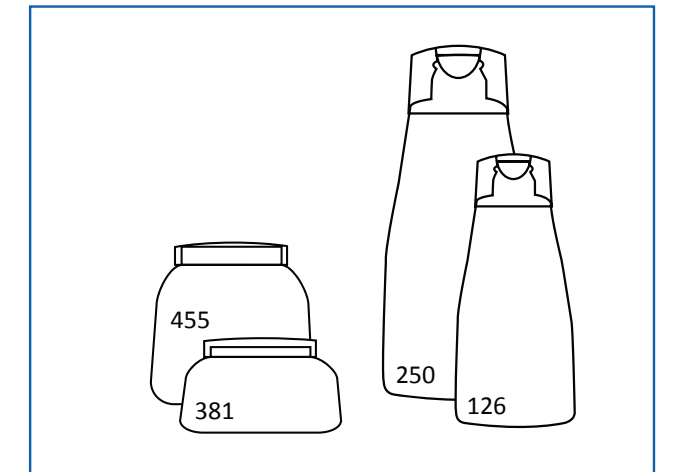

REF	VOL	H mm	D mm	CAP	NECK FINISH	MATERIAL
-----	-----	------	------	-----	-------------	----------

## BOTTLES

126	125	131	31x67	WP1005	Special	PP
249	250	163	38x78	LP	24/410	PP
250	250	182	38x78	WP1005	Special	PP
500	500	220	49x92	WP1005	Special	PP
542	500	215	53x92	WP1005	Special	PP

## JARS

381	50	43	67x80	ST16	53	PP
455	450	99	75x93	D / ST16	70/400	PP



# FOAM

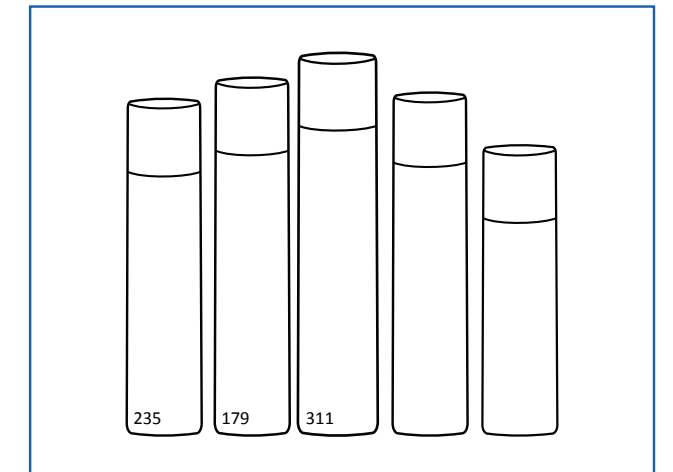

REF	VOL	H mm	D mm	CAP	NECK FINISH	MATERIAL
-----	-----	------	------	-----	-------------	----------

## BOTTLES

235	200	160	48	Foam	38/410	PE
179	230	167	48	Foam	Foam	PE
311	250	185	48	Foam	38/410	PE
574	500	175	70	Foam	43/410	PE



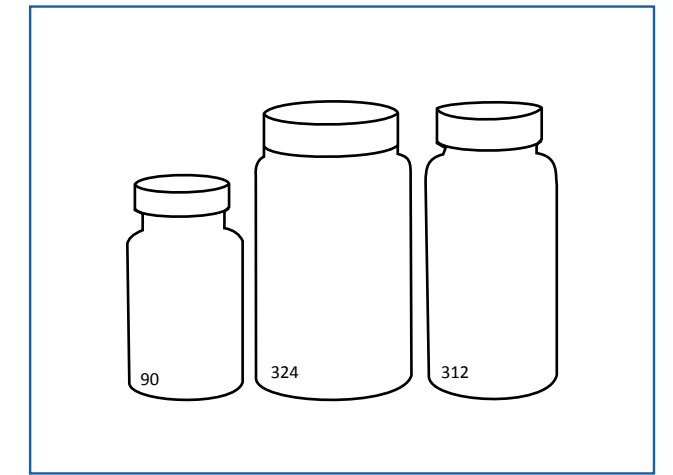

REF	VOL	H mm	D mm	CAP	NECK FINISH	MATERIAL
<b>BOTTLES</b>						
90	130	90	51	Special	38/400	PP
242	250	118	59	Special	38/400	PP
312	250	120	59	Special	38/400	PP
324	320	117	66	ST13 / ST12 / D / AL	58/400	PP



# TALC

REF	VOL	H mm	D mm	CAP	NECK FINISH	MATERIAL
-----	-----	------	------	-----	-------------	----------

## BOTTLES

372	360	160	63x50	Talc	Special	PE
274	430	167	80x45	Talc	Special	PE

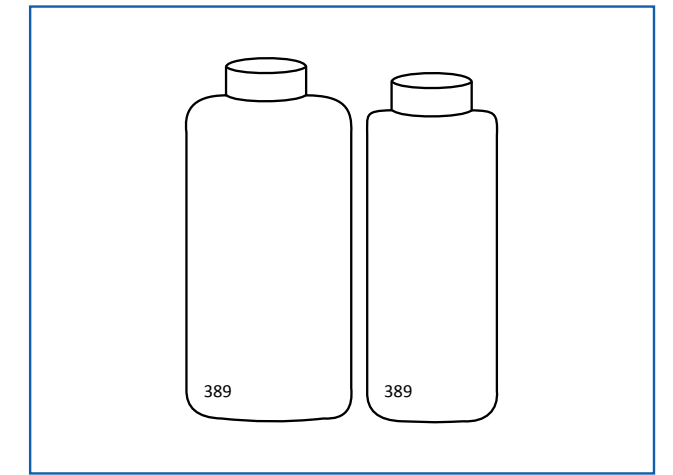

# CAPS

89 / 400

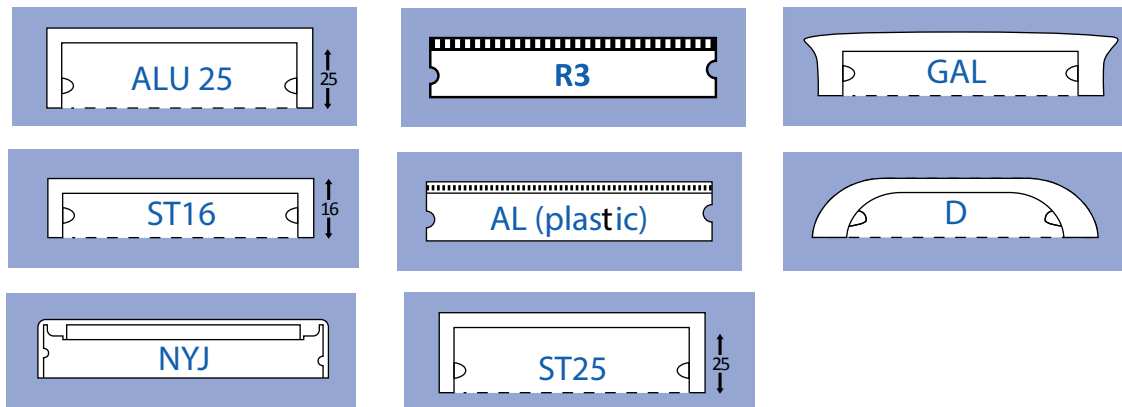

70 / 400

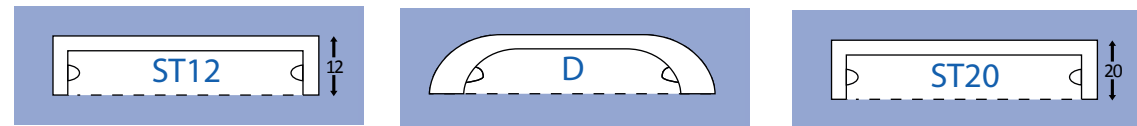

58 / 400

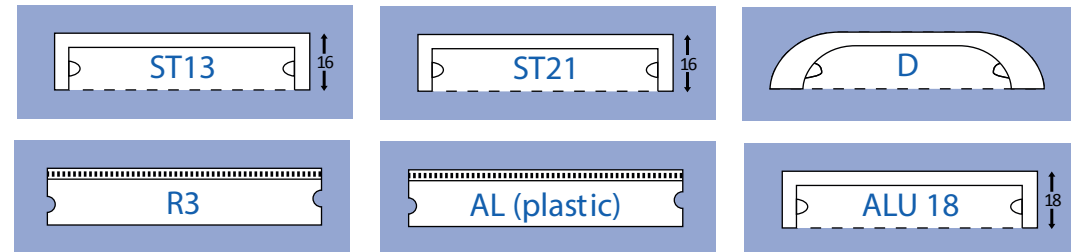

70 / 400

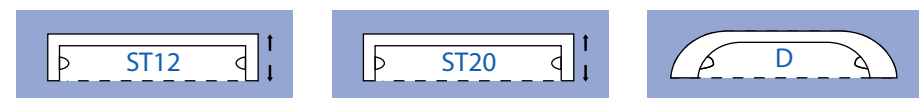

# CLOSURES

28 / 410

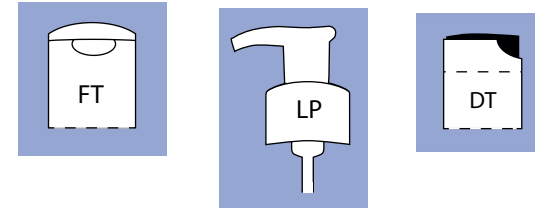

24 / 410

